



GENUINE MEGA

SPECIALTY HAULAGE SOLUTIONS FOR CONSTRUCTION & MINING

➤ **OPERATORS MANUAL**



EQUIPMENT ➤ **PARTS** ➤ **SUPPORT** ➤



700 Osuna Rd. NE · Albuquerque, NM 87113

www.megacorpinc.com

TABLE OF CONTENTS

	Page
Section 1 Definitions and Abbreviations.....	1-1
Section 2 System Description.....	2-1
Section 3 Limitations	3-1
Section 4 Normal Operations	4-1
Section 5 Performance.....	5-1
Section 6 Employment.....	6-1
Appendix Operator’s Checklist	A-1

TABLE OF CONTENTS

SECTION 1

Definitions and Abbreviations

Contents

Manual Usage.....	1-1	Abbreviations.....	1-5
Warning, Caution And Notes	1-1	MAC Overview (Typical)	1-6
Use Of Shall, Will, Should And May	1-1	MTT Overview (Typical).....	1-7
Safety Messages	1-2		

MANUAL USAGE

This technical manual only contains information required to safely operate the MAC/MTT. See the appropriate Maintenance and Operators Safety Manual for specific vehicle system information and maintenance procedures. If your system is not covered in this manual please contact MEGA Corp. Product Support Group at:

US toll free: 1-800-345-8889

Direct: 1-505-345-2661

Visit our website at www.megacorpinc.com for more detailed contact information.

The exact location of the hazards and description of the hazards are reviewed in this section. All personnel working on or operating the MAC/MTT must become familiarized with all the safety messages.

WARNING

Due to the nature of these processes, ensure that all safety information, warnings and instructions are read and understood before any operation or any maintenance procedures are performed. Some procedures take place with heavy components and at moderate heights, ensure proper safety procedures are maintained when performing these actions. Failure to use and maintain proper safety equipment and procedures will cause injury, death or damage to equipment.

WARNING, CAUTION AND NOTES

The following definitions are found throughout the manual and apply as follows:

WARNING

Operating procedures and techniques, which could result in personal injury and/or loss of life if not carefully followed.

CAUTION

Operating procedures and techniques, which could result in damage to equipment if not carefully followed.

NOTE

Operating procedures and techniques that are considered essential to emphasize.

USE OF SHALL, WILL, SHOULD AND MAY

Shall and **Will** – Used when application of a procedure is mandatory.

Should – Used when application of a procedure is recommended.

May - Used to indicate an acceptable or suggested means of accomplishment.

SECTION 1

Definitions and Abbreviations

SAFETY MESSAGES

There are several specific safety messages on this machine. The exact location of the hazards and description of the hazards are reviewed in this section. All personnel working on or operating the machine must become familiarized with all the safety messages.

Make sure that all of the safety messages are legible. Clean the safety messages or replace the safety messages if you cannot read the words. Replace the illustrations if the illustrations are not legible. When you clean the safety messages, use a cloth, water and soap. Do not use solvent, gasoline or other harsh chemicals to clean the safety messages. Solvents, gasoline or harsh chemicals could loosen the adhesive that secures the safety messages. Loose adhesive will allow the safety messages to detach.

Replace any safety message that is damaged or missing. If a safety message is attached to a part that is replaced, install a new safety message on the replacement part.

Toxic Gas Hazard

This safety label is located on the side of the tank and at all water fill entrances.

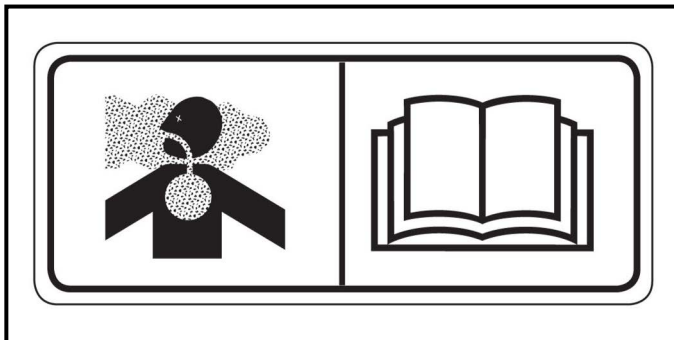

⚠ WARNING

Cutting or welding operation on the inside of the tank can cause the accumulation of toxic gases. Read and understand instructions and warnings in the Maintenance Manual. Failure to provide proper ventilation or breathing apparatus while conducting these operations may result in serious injury or death.

Do Not Operate

This safety label is located on the outside of the front and rear control boxes (if equipped).

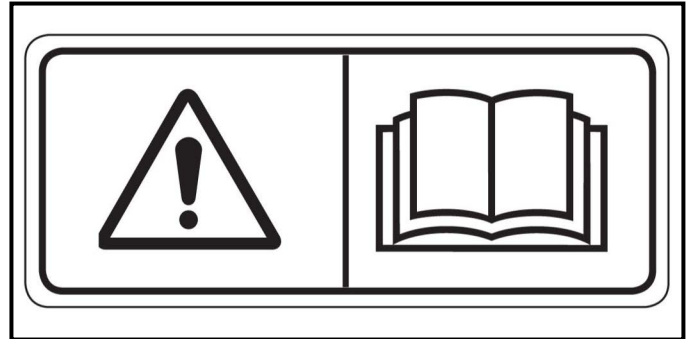

⚠ WARNING

Do not open this control box unless you read and understand the instructions and warnings in the Operator and Maintenance Manual. Failure to follow instructions or heed the warnings could result in serious injury or death.

Backing Runover Hazard

This safety label is located on the rear of the tank and inside the cab.

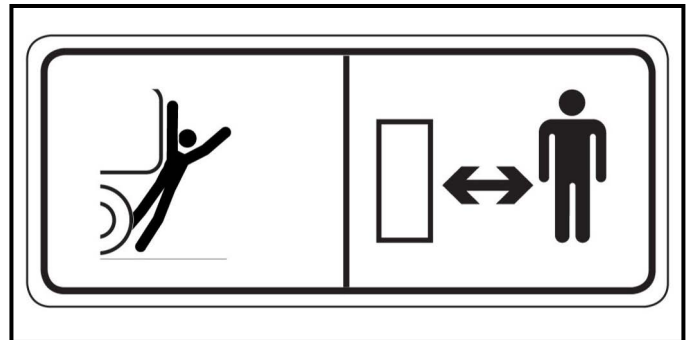

⚠ WARNING

The vehicle is equipped with a back-up alarm. Alarm must sound when operating this vehicle in reverse. Failure to maintain a clear view in the direction of travel could result in serious injury or death.

SECTION 1

Definitions and Abbreviations

Freezing

This safety label is located on the side of the tank, at the sump drain, and on the pump.

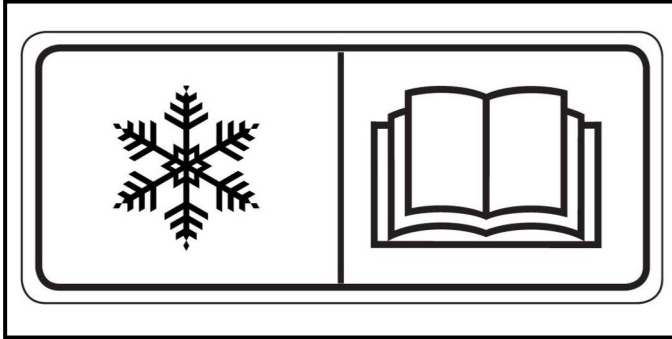

⚠ WARNING

Drain tank, fill pipe and valve in freezing weather. Refer to the Operator and Maintenance Manual for the procedure to follow.

Confined Space

This safety label is located near the water tank access and fill ports.

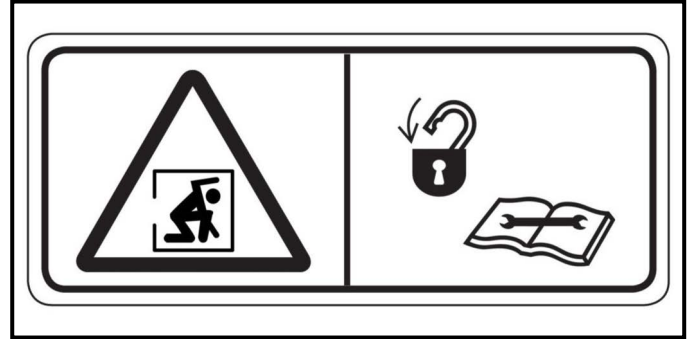

⚠ WARNING

Do not enter confined spaces without following established site specific procedures. Failure to follow proper safety procedures will result in serious injury or death.

Non-Potable

This safety label is located on the side of the tank and sump drain.



⚠ WARNING

Water held within tank is not potable. Do not use tank for transport of water intended for human or animal consumption or serious injury or death may result.

High Pressure Water Cannon

This safety label is located on top of the cab control box.

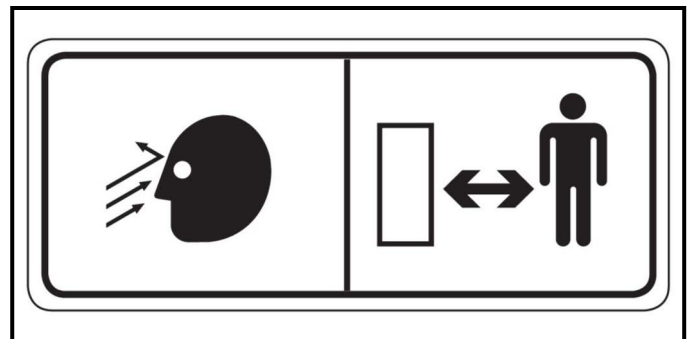

⚠ WARNING

Do not operate the water cannon until all personnel are a safe distance away from the vehicle.

SECTION 1

Definitions and Abbreviations

Do Not Hoist While in Motion

This safety label is located inside the cab.

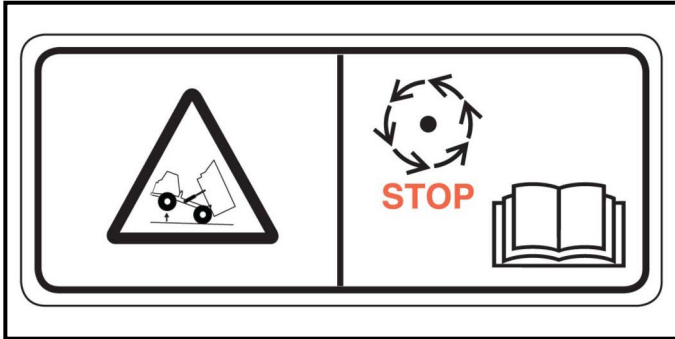

⚠ WARNING

Do not engage hoist cylinders while vehicle is in motion. Before engaging hoist STOP the vehicle. Do not engage hoisting cylinders unless you read and understand the instructions and warnings in the Operator or Maintenance Manual. Failure to follow instructions or heed the warnings will result in injury or death.

Rotating Shaft

This safety label is located on the pump.

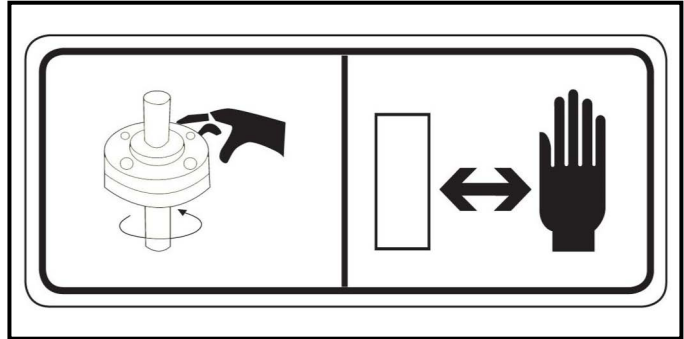

⚠ WARNING

Do not place your hand or tools within pump bell while pump is rotating and/or pressure held within the motor supply hose. Refer to the Operator and Maintenance Manual for the procedures to operate and maintain the pump. Failure to follow proper procedures could result in serious injury.

Fall Hazard

This safety label is located at the top of the front and rear of the tank.

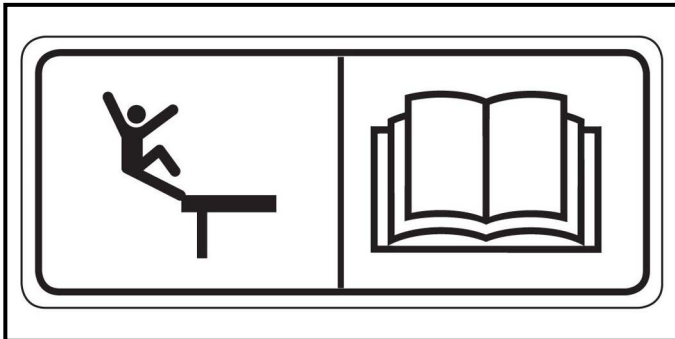

⚠ WARNING

Do not walk on the top of tank without fall arrest PPE. Serious injury or death could occur from a fall.

High Pressure Spray Heads

This safety label is located on the spray bar.

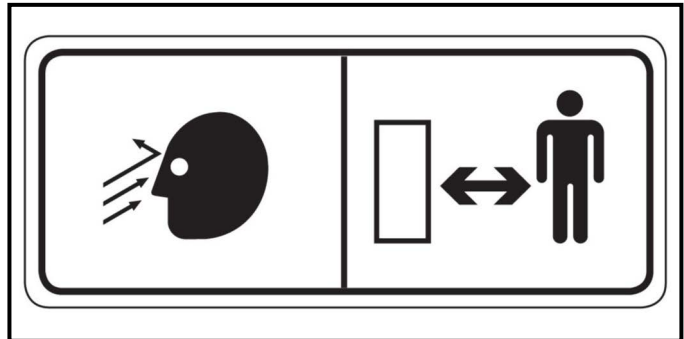

⚠ WARNING

Do not operate spray heads until all personnel are a safe distance away from the vehicle.

SECTION 1

Definitions and Abbreviations

High Pressure Motor

This safety label is located on the hydraulic motor.

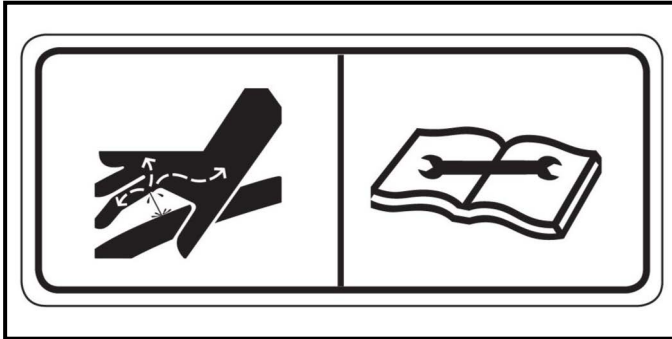

⚠ WARNING

Hydraulic motor and supply lines contain oil under high pressure. Improper removal and repair procedures could cause severe injury. To remove or repair, instructions in the Maintenance Manual must be followed.

IN-CAB SUPPLEMENTS

Checklist

A pocket size Operator's Checklist of all procedures is contained in the Appendix for use in the vehicle cab.

Place a copy of the Appendix Operator's Checklist within the cab for daily use.

Instructional Decals

Instructional decals are included at the beginning of the Appendix. These decals may be cut out and placed in the cab wherever is most convenient for the operator.

ABBREVIATIONS

BFV	butterfly valve
cc	cubic centimeters
CCW	counter clockwise
CW	clockwise
fl. oz.	fluid ounce
ft	feet
fpm	feet per minute
gpm	gallons per minute
kg	kilograms
kPa	kiloPascals
l	liters
lpm	liters per minute
LT	Left as viewed from the operator's position facing forward
m	meters
MAC	MEGA Articulated Conversion
mph	miles per hour
MTT	MEGA Truck Tank
Nm	Newton meters of torque
psi	pounds per square inch
rpm	revolutions per minute
RT	Right as viewed from the operator's
sq ft	square feet
VDC	volts, direct current

SECTION 1

Definitions and Abbreviations

MAC OVERVIEW (TYPICAL)

SIDE VIEW

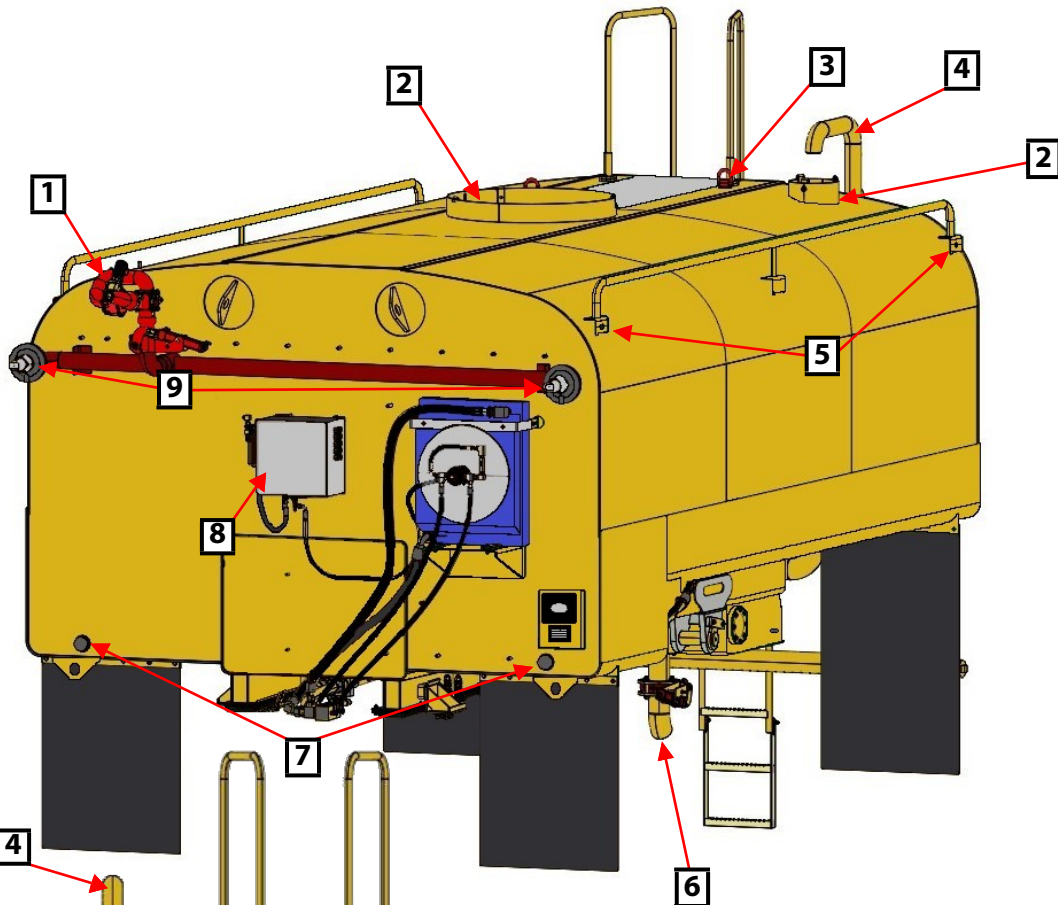

REAR VIEW

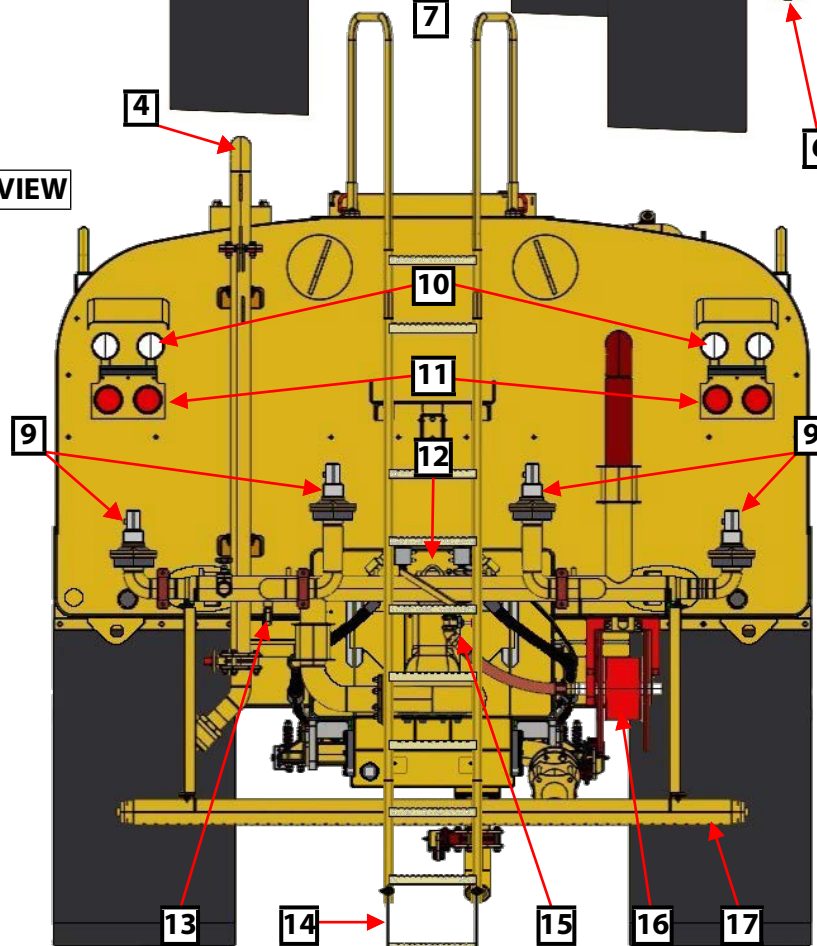

- | | |
|----|-----------------------------|
| 1 | WATER CANNON |
| 2 | TANK FILL PORT |
| 3 | SAFETY TIE-OFF ANCHOR |
| 4 | ANTI-SIPHON FILL PIPE |
| 5 | CLEARANCE LIGHTS |
| 6 | QUICK DRAIN |
| 7 | REMOVABLE PENCIL ANODES |
| 8 | SOLENOID CONTROL BOX |
| 9 | SPRAY HEADS |
| 10 | WORK LIGHTS |
| 11 | STOP, TURN, AND TAIL LIGHTS |
| 12 | WATER PUMP |
| 13 | SPRAY BAR DRAIN |
| 14 | SWING-STEP |
| 15 | HOSE REEL SHUT-OFF VALVE |
| 16 | HOSE REEL |
| 17 | DUMP BAR |

SECTION 1 Definitions and Abbreviations

MTT OVERVIEW (TYPICAL)

SIDE VIEW

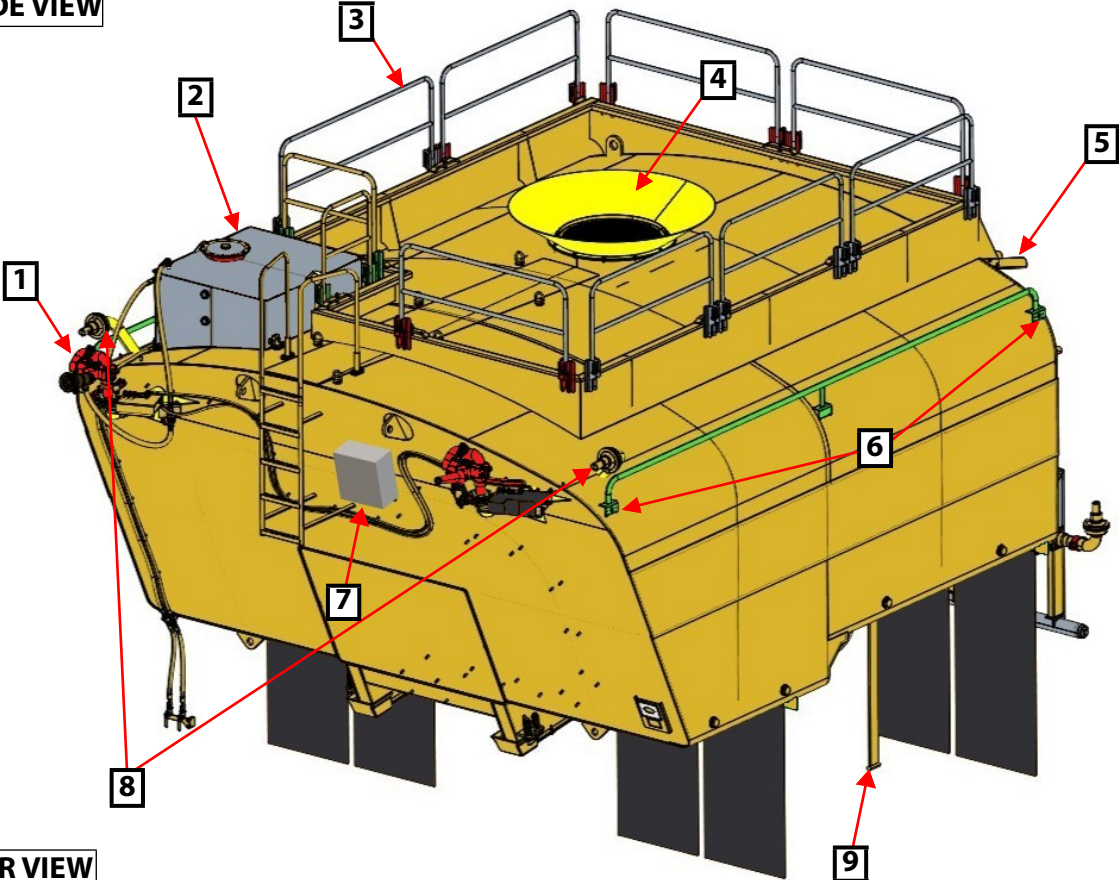

REAR VIEW

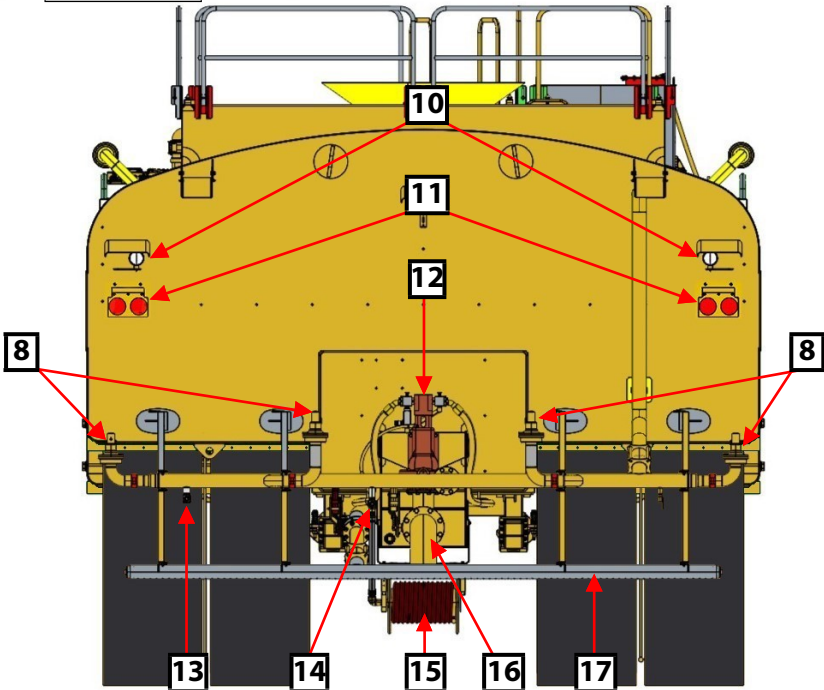

- 1 WATER CANNON
- 2 FOAM AGENT TANK
- 3 FULL HEIGHT FOLDABLE HANDRAILS
- 4 TANK FILL PORT
- 5 DUCKTAIL SPILLWAYS
- 6 CLEARANCE LIGHTS
- 7 SOLENOID CONTROL BOX
- 8 SPRAY HEADS
- 9 ROCK EJECTORS
- 10 WORK LIGHTS
- 11 STOP, TURN, AND TAIL LIGHTS
- 12 WATER PUMP
- 13 SPRAY BAR DRAIN
- 14 HOSE REEL SHUT-OFF VALVE
- 15 HOSE REEL
- 16 QUICK DRAIN
- 17 DUMP BAR

SECTION 1
Definitions and Abbreviations

SECTION 2

System Description

Contents

Water Tank2-1	Fire Suppression System2-16
Water Pumps - M3 & M4 Series2-1	Dump Bar.....2-16
Hydraulic Drive Motor2-2	Hose Reel2-16
Cab Control System (Analog).....2-4	Tank Drain.....2-17
Cab Control System DiSCS® 2.0.....2-5	Suction Loading2-17
Spray System2-13	Water Circulation System.....2-17
Water Cannon Systems2-14	Work Lights2-17

WATER TANK

The MEGA steel water tank consists of a water tunnel, primary floor, vertical baffles, bulkheads, outer skins, internal and external piping. The tank design is patented and known as the MEGA Anti-surge Stabilization System (MASS).

The tank structure is built around and on top of the tunnel super structure. The tunnel provides support to the floor plate, pivot structure, baffles and mounting for the water pump. The floor plates carry loads while the baffles and bulkheads add to tank strength and dampen water surges. External and internal piping carry water from the water pump to spray heads, water cannon, spray bar, hose reel, dump bar and tank drain.

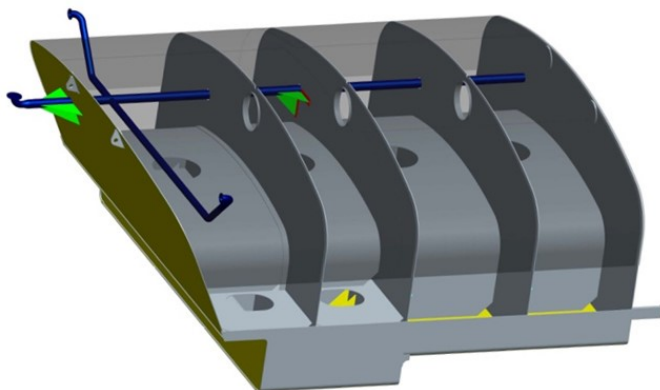

HYDRAULIC SYSTEM

Heat Exchanger



For severe duty applications, an oil to air heat exchanger is located on the front of the tank. The fan motor is powered hydraulically through the pressure circuit and starts when the water pump is activated. Hydraulic oil returns from the water pump drive motor, passes through the heat exchanger which uses forced air to cool the oil before returning the hydraulic oil to the hydraulic reservoir.

WATER PUMPS - M3 & M4 SERIES



The unit is configured with different types of water pumps depending on tank capacity and customer specifications. These water pumps are very similar in design. For the purposes of this manual, the M-4 pump (6 inch inlet & 4 inch outlet) is used to present component information. The unit may instead be equipped with any series M-3 or M-4 pump.

SECTION 2

System Description

M-4 Water Pump Major Components and Functions

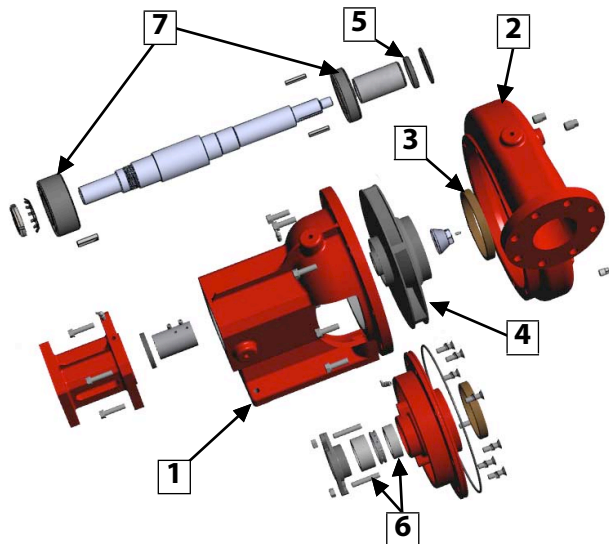

1. BRACKET – Main frame of the pump that bolts to the tanker and provides the means to direct mount the hydraulic drive motor.
2. VOLUTE CASE – A “snail shell” shaped case that encloses the impeller. It is narrow at the center and enlarges from there to the discharge area.
3. WEAR RING – Acts as a bearing surface between the impeller and volute case. Constructed of bronze material.
4. IMPELLER – Rotating wheel attached to the shaft that accelerates the speed of the water producing water flow and pressure.
5. SHAFT SEAL – Confines grease to the inner and outer bearing area while keeping foreign material from entering the bearing area and seals water inside the volute case.
6. ROPE SEAL – Provides a seal around the rotating pump shaft at the volute case. Constructed of a graphite rope material that is designed to drip water and allow shaft lubrication.
7. UPPER/LOWER BEARINGS - Provide roller surface for the pump shaft.

HYDRAULIC DRIVE MOTOR

M-4 Pump Drive Motor And Cross-over Assembly



The M-4 pump rotates clockwise as viewed from the drive end of the assembly.

The hydraulic drive motor may be installed in 4 different orientations depending on the water pump location or application.

Hydraulic Drive Motor Port Identification

The hydraulic drive motor requires hydraulic flow from a valve to the motor pressure port, return oil flow to the hydraulic reservoir and a free to tank case drain.

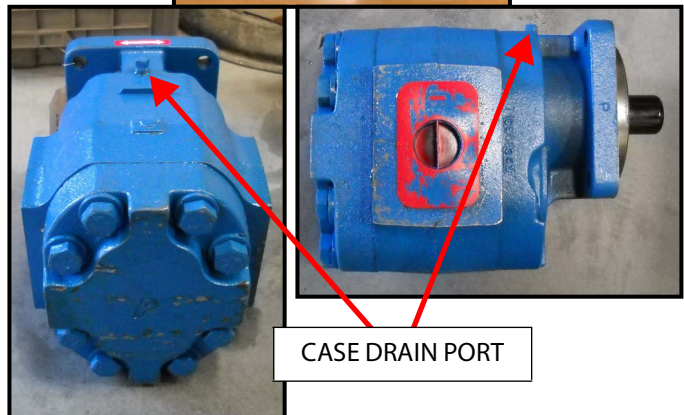
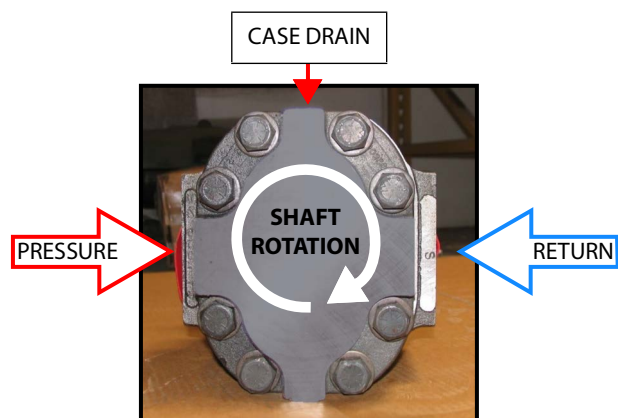

SECTION 2

System Description

Hydraulic Drive Motor Speed Control (Crossover Assembly)

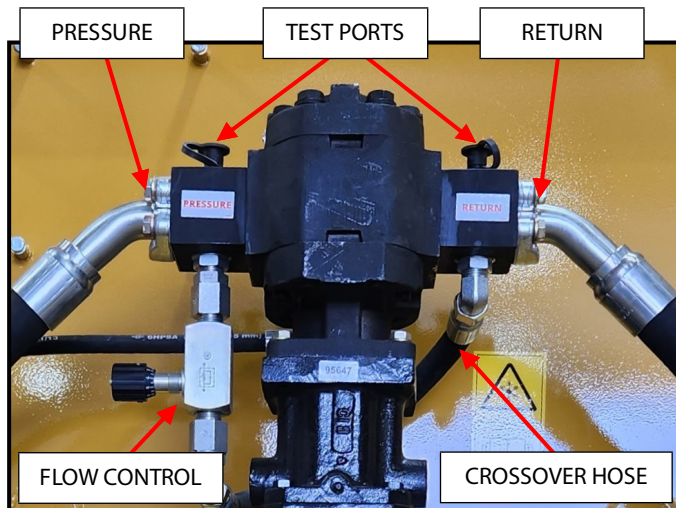

The hydraulic drive motor speed control (crossover assembly) consists of a flow control valve, 2 hydraulic manifolds, crossover hose and test ports.

Hydraulic Flow Control Valve



The hydraulic flow control valve is directional and typically mounted on the **pressure** manifold of the hydraulic drive motor. The arrow on the body indicates the direction of oil flow to meter the bypassing oil. The adjusting knob on the valve allows adjustment of the oil flow to bypass the drive motor, up to 135 lpm (35 gpm) or up to 700 rpm.

NOTE

Rpm increase/decrease will vary depending on the size of hydraulic drive motor.

By turning the adjusting knob clockwise, the hydraulic oil that is bypassing will be reduced, increasing the speed of the water pump. Turning the knob counter-clockwise will increase the volume of oil being bypassed reducing the water pump speed.

NOTE

If the flow control is reversed, the flow control adjusting knob will not function and the full flow capacity of the valve will bypass. This can result in water pump rpm being below specifications.

Hydraulic Drive Motor Activation

The hydraulic drive motor on MEGA tankers are typically driven by the chassis hoist hydraulic system. The activation can be controlled by the following:

- Existing Electric Hoist Valve
The MEGA cab control pump switch commands the hoist valve to operate by sending an electric signal to the electric solenoid on the hoist valve. This operates the hoist valve, diverting the hydraulic oil to the water pump drive motor.
- Pilot Operated Diversion Valve
A remote mounted diversion valve that receives an electric signal from the cab control pump switch to activate a pilot control to move a spool within the diversion valve redirecting the hydraulic oil to flow to the water pump drive motor. Typically this type of valve is installed between the hoist pump and the water pump drive motor.
- Existing Mechanically Operated Hoist Valve
Typically used on early model trucks with a pneumatic system. This system is operated by the cab control pump switch sending an electric signal to an electric/pneumatic solenoid to control a pneumatic cylinder. When the pneumatic cylinder operates it moves the hoist spool valve to divert hydraulic oil to the water pump drive motor.

SECTION 2

System Description

CAB CONTROL SYSTEM (ANALOG)

Multi-function control box that is mounted in the vehicle cab to control all water tank functions. Controls are available for the water cannon, intermittent spray, water pump, work lights, foam suppression, adjustable nozzle, system, spray heads, spray bar, gravity dump bar and tank drain valve. The control box also provides indications of tanker water level and a system fuse holder. The cab controls requires 24 VDC vehicle power to operate.

The control functions operate as follows:

Control	Function
JOYSTICK	Sends command signals to the logic box (electric water cannon) or hydraulic control valve assembly (hydraulic water cannon) to move the water cannon left, right, up and down.
FOAM	Open or closes the foam agent in-line control valve.
FOG	On adjustable nozzle water cannons, adjusts nozzle to produce a fog pattern (hold for adjustment)
STREAM	On adjustable nozzle water cannons, adjusts nozzle to produce a stream pattern (hold for adjustment)
TIMER OFF	Sets OFF time (variable adjustment 5-100 sec) between timer cycles of selected spray heads and dump bar when the timer switch is in the intermittent position.
TIMER ON	Sets ON time (variable adjustment 5-100 sec) of selected spray heads and dump bar when the timer switch is in the intermittent position
PUMP	Routes vehicle hydraulic system pressure and flow to the water pump hydraulic drive motor.
MONITOR	Opens the water cannon BFV.
LIGHTS	Provides power to work lights.
TIMER	Activates or deactivates system timer function.
DRAIN	Opens or closes tank drain BFV.
DUMP BAR	Opens or closes dump bar BFV.
WATER LEVEL	Indicates tank water level.
SYSTEM	Provides power for all cab control functions.
LT VSS	Opens or closes left vertical side spray head.



The control box and joystick have a modular design, which allows the joystick to be detached from its holding bracket and operated separately as needed. Older hydraulic control boxes do not have this functionality, but they can be upgraded to the latest design by MEGA.

SECTION 2

System Description

Control	Function
LT REAR	Opens or closes left rear spray head.
LT CENTER	Opens or closes left center rear spray head.
RT CENTER	Opens or closes right center rear spray head.
RT REAR	Opens or closes right center rear spray head.
RT VSS	Opens or closes right vertical side spray head.
AUX 1	Reserved for specialized functions.
AUX 2	Reserved for specialized functions.

CAB CONTROL SYSTEM DISCS® 2.0

Overview



The DiSCS® compact switch pad is based on CAN bus protocol and is water and dust resistant. Switch pad LEDs light up in RGB colors, indicating different watering patterns and controls.

Basic features are:

- Simple and rugged construction for heavy-duty operations
- Adjustable switch pad brightness
- Fully adjustable RAM® mount (where applicable)
- In-cab water level indicating system
- Self-contained GPS used in distance and speed based program modes to automatically control selected rear spray head valves. GPS also enables selected spray head valves to open above 5 mph and close at 3 mph or less.
- Total system pause function
- Work light and auxiliary controls

SECTION 2 System Description

Features

Manual Spraying



With manual spraying the operator can select each spray head independently and can be used without GPS connection.

Time Based Spraying (Banding)



Operator can cycle on/off periods of spray using selected time intervals.

Distance Based Spraying (Checkerboard)

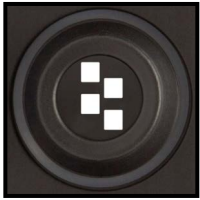

Alternating intermittent watering patterns to reduce water consumption and ensure one steering tire and one drive tire remain on a dry surface.

Speed Based Spraying (Continuous Rate)



Sequence-based intermittent spray system operation uses PWM (Pulse Width Modulation) to vary the amount of water flow while maintaining a continuous rate of water application, dependent on speed of travel.

Control Pad Switch Brightness

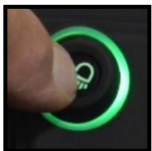

Press and hold work light button for two (2) seconds (work lights will turn off). The brightness level will cycle down in 25% intervals for every two (2) seconds the button is held. 100% > 75% > 50% > 25% > 100%

Operation



Start-Up

When the prime mover key switch is first turned on, the system performs a self-test and will quickly flash all switch pad LEDs then turn off.

NOTE

If the switch pads have any buttons that do not light or the flash sequence persists, contact your service department for repair.

Switch Pad Function & Identification



System Power

- Turns system power - ON/OFF
- Standby mode - LED OFF
- System on - STEADY GREEN



Water Pump

- Turns water pump ON/OFF
- Standby mode or pump timed out - LED OFF
- Pump on - STEADY GREEN
- Fault - FLASHING RED/YELLOW



Water Level

- Indicates tank water level
- Greater than 90% - ALTERNATING GREEN/WHITE
- 90% to 50% - STEADY GREEN
- 50% to 25% - STEADY YELLOW
- 25% to 5% - STEADY RED
- Less than 5% - ALTERNATING RED/WHITE
- Fault - ALTERNATING RED/YELLOW

SECTION 2

System Description



Time Based Programming

Activate the time based program mode

- Standby mode - LED OFF
- Timer active - STEADY GREEN



Left Rear Spray Head (LT R)

Turns left rear spray head on/off

- Standby mode - LED OFF
- Valve open - STEADY GREEN
- Valve closed during intermittent programming - STEADY BLUE



Speed Based Programming

Activates speed based program mode

- Standby mode - LED OFF
- Programming on - STEADY GREEN
- No GPS lock - ALTERNATING RED/GREEN
- Operation not allowed - ALTERNATING YELLOW/BLUE



Left Center Spray Head (LT RC)

Turns left center spray head on/off

- Standby mode - LED OFF
- Valve open - STEADY GREEN
- Valve closed during intermittent programming - STEADY BLUE



Distance Based Programming

Activates distance based program mode

- Standby mode - LED OFF
- Program on - STEADY GREEN
- No GPS lock - ALTERNATING RED/GREEN
- Operation not allowed - ALTERNATING YELLOW/BLUE



Rear Facing Work Lights

Turns the MEGA supplied work lights on/off and changes the switch LED brightness

- Hold to adjust brightness
- Standby mode - LED OFF
- Work lights on - STEADY GREEN



Auxiliary Function

Reserved for optional equipment

- Standby mode - LED OFF
- Function on- STEADY GREEN



Wet +

Adjusts time, distance and speed based programming

- Standby mode - LED OFF



Auxiliary Water Cannon

Number 1, 2, or 3: Switches between multiple water cannons (when equipped)

- Selected, BFV open - STEADY GREEN
- Selected, BFV closed - STEADY YELLOW
- Standby mode - LED OFF



Wet -

Adjusts time, distance and speed based programming

- Standby mode - LED OFF



Left Vertical Spray Head (LT VSS)

Turns left vertical spray head on/off

- Standby mode - LED OFF
- Open - STEADY GREEN



Dry +

Adjusts time, distance and speed based programming

- Standby mode - LED OFF



Dump Bar

Turns dump bar on/off

- Standby mode - LED OFF
- Valve open - STEADY GREEN
- Valve closed during intermittent programming - STEADY BLUE



Dry -

Adjusts time, distance and speed based programming

- Standby mode - LED OFF

SECTION 2

System Description



Pause

- Pauses all active spray functions
- Standby mode - LED OFF
- Pause - FLASHING YELLOW
- All active functions pause (close) - STEADY YELLOW



Hose Reel

- Allows continuous use of hose reel
- Standby mode - LED OFF
- Function active - FLASHING YELLOW
- Active functions will pause (close) - STEADY YELLOW



Quick Drain

- Turns quick drain on/off
- Standby mode - LED OFF
- Open - STEADY GREEN



Right Vertical Side Spray Head (RT VSS)

- Turns right vertical spray head on/off
- Standby mode - LED OFF
- Open - GREEN LED



Right Center Spray Head (RT RC)

- Turns right center spray head on/off
- Standby mode - LED OFF
- Valve open - STEADY GREEN
- Valve closed during intermittent programming - STEADY BLUE



Right Rear Spray Head (RT R)

- Turns right rear spray head on/off
- Standby mode - LED OFF
- Valve open - STEADY GREEN
- Valve closed during intermittent programming - STEADY BLUE



Suction Load

- Enables suction load option
- Standby mode - LED OFF
- Active - STEADY GREEN
- All other functions will be 'locked-out' and will signal an 'operation not allowed' fault when pressed

System Protection Features



Water Pump Time Out Function

After 100 seconds of no active discharge, the water pump will automatically turn off (time out).



Pump Protection Feature

If water level sensor reads water level below 5% for more than 5 seconds, water level button LED will flash RED/WHITE and automatically shuts off water pump.



Pause Fault Indication

Pressing any function while pause is active will result in a fault, indicated by pause and function buttons ALTERNATING BLUE/YELLOW.



Hose Reel Fault Indication

Pressing any function while hose reel is active will result in a fault, indicated by pause and function buttons ALTERNATING BLUE/YELLOW.

Water Cannon Joystick Function & Identification



The water cannon joystick gives the operator complete control of the water cannon system. The water cannon system has options of FAN/FOG adjustable nozzles, as well as fire suppressing foam education.



Water Cannon Butterfly Valve

- Opens/closes butterfly valve
- Press to open- Light under joystick illuminates at 100% brightness.
- Press to close- Light under joystick reduces to 20% brightness.

SECTION 2

System Description



Water Pump

Turns water pump on/off
 •Press and release - ON/OFF
 •LED on switch pad - STEADY GREEN
 •Standby mode or pump timed out - LED OFF



Adjustable Nozzle Stream

Moves nozzle to stream position
 •Press and hold - ADJUSTS NOZZLE



Adjustable Nozzle FAN/FOG

Moves nozzle to fan/fog position
 •Press and hold - ADJUSTS NOZZLE



Foam Agent

Open/close foam agent valve
 •Press and hold for 3 seconds - OPEN/CLOSE



Pause

Pauses all active spray functions
 •Press and release - FLASHING YELLOW



Time Based Program Mode

Based on **time-on** and **time-off** settings. System and water pump must be **on** for this program mode to activate. Time based programming will control the rear spray heads and the dump bar **only**. All other functions can be activated manually while in time based programming but will not be controlled through the program settings. Time based programming will turn the selected spray heads **on** and **off** at the selected time intervals. Pause, hose reel, and low water protection are functional in this mode.



Wet +

Press to advance setting - **Longer** wet time (on)



Wet -

Press to advance setting - **Shorter** wet time (on)



Dry +

Press to advance setting - **Longer** dry time (off)



Dry -

Press to advance setting - **Shorter** dry time (off)

The time settings available are:

- 3 seconds
- 6 seconds
- 9 seconds
- 20 seconds
- 30 seconds

The **wet/dry** switches advance the timer settings. Every press of the switch will advance the time setting 1 time interval. Select the rear spray heads that are required to activate in this mode.

Button Color	Time Cycle
White	3 Seconds
Blue	6 Seconds
Yellow	9 Seconds
Green	20 Seconds
Magenta	30 Seconds

Example:

- Timer is set for 3 seconds on and 3 seconds off, press **Wet +** switch one time, the time on will advance to 6 seconds on and change the switch color from white to blue.
- Timer is set for 20 seconds on and 9 seconds off, pressing **Dry -** switch one time, the time off will decrease to 6 seconds and the switch color will change from yellow to blue.

SECTION 2

System Description

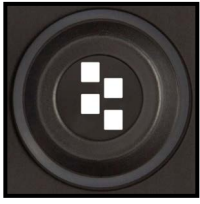

Distance Based Program Mode

Vehicle speed input is acquired from the MEGA self-contained GPS system that provides vehicle ground speed to the controller. The controller calculates the distance and signals the rear spray heads when to turn **on** and **off** creating an alternating pattern (checker boarding). This mode reduces water consumption and controls dust while allowing 1 steer tire and 1 drive tire to remain on a dry surface. This mode can be adjusted to spray water a width of a haul road at slower speeds without crossing the center line. It can produce a wide pattern that can carry over into an adjacent lane when the spray head angles are properly adjusted. **System, water pump and at least one spray head must be on and GPS must have satellite lock.**

Dry Coverage Distance

Using 'Dry +' and 'Dry -' function buttons the operator can adjust the dry coverage distance in the distance based program mode.



Dry +

Press to advance setting **lengthen** dry strip



Dry -

Press to advance setting **shorten** dry strip

Wet Coverage Distance

Using 'Wet +' and 'Wet -' function buttons the operator can adjust the **wet coverage distance** in the distance based program mode.



Wet +

Press to advance setting **lengthen** wet strip



Wet -

Press to advance setting **shorten** wet strip

Button Color	Distance
White	0 Meters
Blue	5 Meters
Yellow	10 Meters
Green	20 Meters
Magenta	30 Meters

Button Color	Distance
White	15 Meters
Blue	20 Meters
Yellow	30 Meters
Green	45 Meters
Magenta	60 Meters

Distance based programming controls only the rear spray heads. All other functions can be activated manually while in distance based programming mode but will not be controlled by the distance based settings. Distance based programming will turn the selected spray heads **on and off** at the selected distance intervals. Pause and low water protection are functional in this mode. **All selected spray heads will turn off at 4.8 KPH (3 MPH) or less.**

SECTION 2 System Description

Figure 2-1: Examples of Distance Based Settings

SETTINGS:
EVEN WET/DRY
DISTANCE

SETTINGS:
DRY DISTANCE
0 METERS

SETTINGS:
LONG WET STRIP
SHORT DRY STRIP

SETTINGS:
SHORT WET STRIP
LONG DRY STRIP

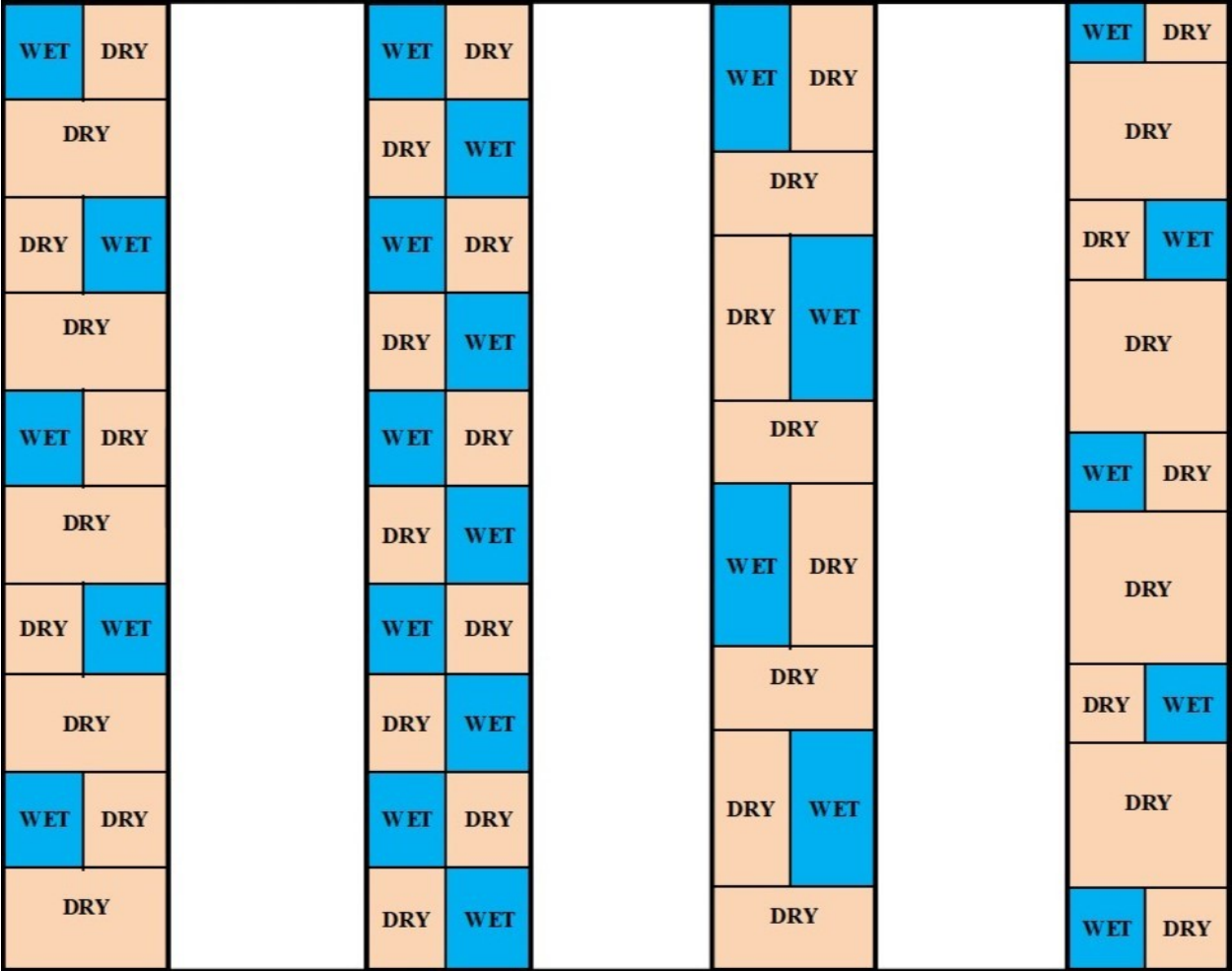

SECTION 2

System Description



Speed Based Program Mode

Vehicle speed input is acquired from the MEGA self-contained GPS system that provides vehicle ground speed to the controller. The controller determines the watering rate Pulse Width Modulation (PWM) for the selected spray heads. PWM is the pulsing of spray heads to deliver a desired coverage percentage of water that has been selected through the **rate** setting. Automatic water reduction will occur before the PWM mode begins, this is when the unit turns **off** the 2 inner spray heads prior based on the **speed** setting selected. As the vehicle speed is reduced the PWM pattern will begin, this is where it pulses the 2 outer spray heads to achieve the requested percentage of water coverage (**rate**). **System, water pump and at least one spray head must be on and GPS must have satellite lock.**

Coverage Percentage Setting

Using the 'Wet +' and 'Wet -' function buttons the operator can adjust the **coverage percentage** of the speed based program mode.



Wet +
Press to advance **rate** setting **more** water coverage percentage.



Wet -
Press to advance **rate** setting **less** water coverage percentage.

Button Color	Coverage
White	15%
Blue	30%
Yellow	50%
Green	75%
Magenta	90%

Program Speed Setting

Using the 'Dry +' and 'Dry -' function buttons the operator can adjust the **maximum speed** setting for the speed based program mode.



Dry +
Press to advance setting **increase** maximum program speed



Dry -
Press to advance setting **decrease** maximum program speed

Button Color	Speed
White	8 KPH/5 MPH
Blue	16 KPH/10 MPH
Yellow	24 KPH/15 MPH
Green	32 KPH/20 MPH
Magenta	40 KPH/25 MPH

The speed based program mode will only control the rear spray heads. All other functions can be activated manually while in speed based programming mode but will not be controlled through the speed based program settings. **All selected spray heads will turn off at 4.8 kph (3 mph) and less.**

Faults:



No GPS Lock - Flashing RED/ GREEN



No connection to GPS receiver - Flashing RED/BLUE

SECTION 2

System Description

SPRAY SYSTEM

The spray system consists of up to 8 hydraulic or pneumatic actuated spray heads, cab controls, solenoid control box assembly and hydraulic or pneumatic hosing.

Pneumatic Solenoid Control Box



The control box assembly is mounted to the forward bulkhead or top skin of the water tanker. The assembly contains pneumatic solenoid valves that direct pneumatic pressure to the spray head as commanded by the cab controls. The solenoids receive pneumatic pressure from the vehicle and 24 VDC power from the cab controls.

Pneumatic Spray Head



A two piece aluminum or stainless steel valve body and adjustable ring mounted to a water supply header pipe. The upper portion of the valve body is an air chamber with a diaphragm and guide disk assembly attached to the

bottom. The air chamber receives pressurized air from the solenoid control box as commanded by the cab control switch. When the upper portion of the valve body is pressurized the guide disk will seal the opening on the lower portion of the valve and stop water flow.

When the cab control system is OFF and the water pump is OFF the air chamber incorporates a spring that will apply pressure to the guide disk assembly and seal the opening on the lower portion of the valve and stop flow. Air pressure is removed from the upper portion of the valve body when the water pump is ON and the cab control switch ON. Pressurized water from the header pipe will unseat the guide disk and water will flow from the lower portion of valve.

Hydraulic Solenoid Control Box



The control box assembly is mounted to the forward bulkhead or top skin of the water tanker. The assembly contains hydraulic solenoid valves that direct hydraulic pressure to the spray head as commanded by the cab controls. The solenoids receive hydraulic pressure from water pump oil circuit and 24 VDC power from the cab controls.

Hydraulic Spray Head



A two piece aluminum or stainless steel valve body, hydraulic cylinder and adjustable ring mounted to a water supply header pipe. The upper portion of the valve body contains a hydraulic cylinder that receives hydraulic pressure from the system solenoid control box as commanded by the cab control

switch. When the hydraulic cylinder on the upper portion of the valve body is pressurized, the cylinder extends to contact the guide disk and seal the opening on the lower portion of the valve and stop water flow.

When the cab control system is OFF and the water pump is OFF the upper valve body incorporates a spring to apply pressure to the guide disk to seal the opening on the lower portion of the valve and stop flow. When the spray head switch is turned on, hydraulic pressure retracts the hydraulic cylinder and pressurized water from the header pipe will unseat the guide disk and water will flow from the lower portion of valve.

Spray Head Adjustable Rings

The adjustable ring is used to control fan width and water flow. The ring may be loosened and rotated to expose more or less of the lower valve opening to control water fan width from 15° (narrow fan width) to 90° (full fan width). The ring also may be rotated to a fine spray (1/4" slot height) or heavy spray (3/8" slot height) as shown below to increase or decrease overall water flow.

SECTION 2

System Description

WATER CANNON SYSTEMS

The system is comprised of a water cannon (hydraulic or electric), hydraulic control valve assembly or logic box, butterfly valve assembly, nozzle and controls.

NOTE

Some units are equipped with two or three water cannons mounted in different locations. Additional switches are provided to select between the primary and auxiliary water cannons. Typically, one joystick will operate the selected water cannon.

Hydraulic Water Cannon



A metal waterway that directs a stream of water in elevation (up-down) and rotation (right-left). Hydraulic motors move the waterway based on hydraulic flow from the hydraulic control valve assembly as commanded

by the cab control joystick. The water cannon is threaded to a flanged pipe that mounts directly above the BFV. The water cannon provides mounting for different types of nozzles.

Hydraulic Control Valve Assembly



The assembly contains hydraulic solenoid valves that direct hydraulic pressure to the hydraulic motors on the water cannon and BFV cylinder as commanded by the cab

controls. A pressure relief valve is incorporated in the manifold block to protect the water cannon system against over pressurization. The assembly is mounted to the tank lower flange and receives hydraulic pressure from the vehicle hydraulic pump.

Hydraulic BFV Assembly



A hydraulically operated valve opens or closes to control water flow. The hydraulic cylinder receives hydraulic pressure from the control valve or solenoid control box assembly as commanded by the cab control switch. The assembly is clamped between upper and lower pipe flanges.

Electric Water Cannon



A metal waterway that directs a stream of water in both elevation (up-down) and rotation (right-left). 24 VDC electric motors move the waterway based upon filtered electronic signals from the logic box as commanded by the cab control joystick. The water

cannon is threaded to a flanged pipe that mounts directly above the BFV. The water cannon also provides mounting for a variety of different nozzles.

Logic Control Box



An electric controller that provides 24 VDC power to the water cannon system. The controller provides system protection against polarity reversal, under-voltage, over-voltage, feeder fault and excessive current flow. The controller is also capable of providing protection for some electric adjustable nozzles. The logic box is typically mounted in the cab.

Electro-Pneumatic BFV Assembly



An electro-pneumatic valve controls the flow of water. A 24 VDC solenoid receives commands from the cab control water cannon BFV switch through the logic box to route pressurized air to an air chamber which opens or closes a 3" valve. The assembly is clamped between upper and lower pipe flanges.

SECTION 2

System Description

Water Cannon Nozzles And Stream Shapers



Straight/Smooth Bore Nozzle

A cone shaped 1.5" inch diameter nozzle that directs water flow. The nozzle has a built in stream shaper that smooths water flow to increase water stream distance. An additional external stream shaper can be used instead of the supplied internal shaper.



Straight/Smooth Bore (Stackable)

A segmented cone shaped nozzle that directs water flow. The nozzle opening is adjusted by removing segments to acquire the most efficient nozzle opening for a given water pump operating pressure. Nozzle segment diameters are 1", 1½", 1¾" and 2". The nozzle requires an in-line stream shaper to increase water stream distance.



In-Line Stream Shaper

A performance enhancer that is mounted between the water cannon outlet and the selected straight bore nozzle. The stream shaper pathway is a honeycomb style channel which creates a laminar water flow to increase water stream distance.

Adjustable Nozzles

The two main categories of adjustable nozzles are: **fog/stream** and **fan/stream**. They can be either manually or remotely adjusted. Some nozzles are configured for fire suppression foam education.

FOG/STREAM: A modified straight bore nozzle that allows the operator to adjust selected water stream patterns from fog to stream.

FAN/STREAM: A modified straight bore nozzle that allows the operator to adjust selected water stream patterns from flat fan to stream. The flat fan pattern orientation is adjustable from horizontal to vertical by reorienting the nozzle on the water cannon.

Manual Adjustable Nozzle

The nozzle outer barrel is moved **manually** to obtain the fog or stream pattern.



Remote Adjustable Nozzle (Electro-Hydraulic)

The nozzle outer barrel is moved by a **hydraulic** actuator to obtain the fog or stream pattern.



Remote Fan/Stream Adjustable (Electric)

The nozzle outer barrel is moved by an **electric** actuator to obtain the fan or stream pattern.



SECTION 2

System Description

FIRE SUPPRESSION SYSTEM

A system that consists of a 60, 120 or 200 gallon stainless steel holding tank, an electric or pneumatic actuated shut-off valve, in-cab control switch, hosing and a foam education nozzle mounted to the water cannon.

Foam Concentrate Tank



A stainless steel tank mounted on the forward upper portion of the water tank. The holding tank contains a supply tube that extends to the bottom of the tank. It

connects to a flexible hose at the top of the tank and then routed to the foam agent shut-off valve. The tank also contains a pressure/vacuum cap which keeps foreign matter out of the tank while providing for pressure relief and air displacement during temperature changes.

Electric/Pneumatic Shut-off Valve

The in-line shut-off valve is mounted on the foam tank upper lip and is controlled by the in-cab control foam switch. The shut-off valve is actuated by either an electric or pneumatic actuator that is controlled by the in-cab control switch. Once the shut-off valve is opened, foam concentrate will flow from the holding tank to the water cannon nozzle if the water cannon and water pump switches are ON.

Foam Education Nozzle



A manual or remote adjustable (fog/stream) nozzle is attached to the water cannon waterway. The nozzle inner housing uses monitor high pressure water to create a venture effect that will create a suction force that pulls

foam concentrate from the holding tank. Once foam concentrate is flowing, the nozzle proportions foam concentrate, water and air to produce finished foam. The nozzle can be adjusted to allow control of foam solution at a rate of 1%, 3% or 6%. Rate adjustment is obtained by changing the orifice disk size in the foam concentrate supply line at the nozzle.

DUMP BAR



The dump bar is a pipe suspended below the main spray bar at the rear of the water tank and can be either gravity fed from the sump of the tank or pressurized from the water pump. The pressure dump bar has 1 row of 3/8 inch holes in the bottom of the pipe while the gravity dump bar has 2 rows of 3/8 inch holes. A hydraulically or pneumatically operated butterfly valve controls the water supply to the dump bar. The BFV is controlled electrically from the cab controls and is actuated by a hydraulic cylinder or pneumatic valve.

HOSE REEL



Hose reels can be hydraulic rewind, spring rewind or manual rewind. The reel assembly is located on the bottom aft end of the water tank and fitted with a 1" or 1.5" diameter reinforced rubber hose and a fire fighting style nozzle. The hose reel assembly receives pressurized water from the spray bar.

SECTION 2

System Description

TANK DRAIN

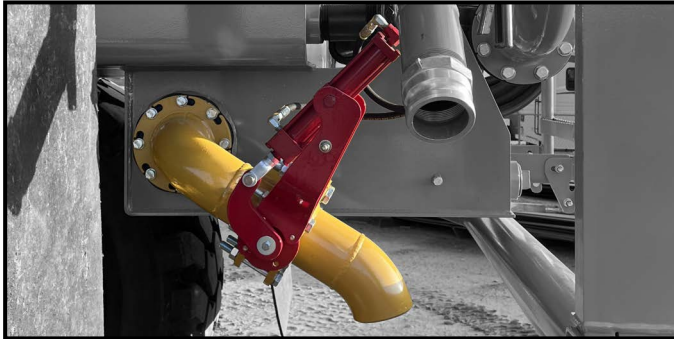

The tank drain can be either gravity or pressure fed. It consists of a pipe assembly and a manual, hydraulic or pneumatic BFV attached to the water tank sump box or pump. It is used to drain water from the water tank. The BFV is controlled electrically from the cab controls or (manually if it's a manual BFV) and is actuated by a hydraulic or pneumatic actuator.

WATER CIRCULATION SYSTEM

A system that consists of a hydraulic butterfly valve assembly and a perforated 4" pipe located inside the water tank. The system diverts the flow of water from the spray system to the perforated pipe, circulating the water in the tank. The circulation valve must be closed to operate the spray system or water cannon.

WORK LIGHTS

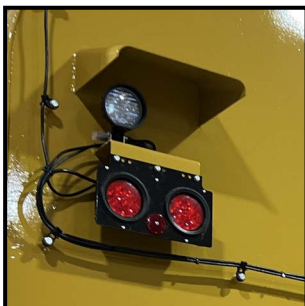

The MEGA supplied LED work lights are activated by the work light switch on the cab controls.

SUCTION LOADING



For water tankers utilizing the M4 water pump, a second water pump is mounted (typically near the water pump sump) at the rear of the tanker. The suction loading station is equipped with a manual diversion valve that will switch the hydraulic oil flow from the main discharge pump drive motor to the suction loading pump drive motor. When oil is diverted to the suction loading drive motor it can pull water from a holding pond and fill the water tanker. The suction loading option includes lengths of 4 inch suction hose equipped with quick couplers and a foot valve which incorporates a check valve and debris screen. The suction hoses are typically stored in tubes either built into the water tanker or a hanging tube arrangement.

Suction loading is achieved on smaller tankers utilizing the M3 water pump by manipulating a series of valves to divert flow from the suction inlet of the M3 water pump.



SECTION 2

System Description

SECTION 3 Limitations

Contents

Water Pump.....3-1

WATER PUMP

The following cautions are operational limitations of MEGA water pumps. Failure to heed these cautions may result in reduced pump life and severe water pump damage.

PUMP MODEL	RPM
M-3 Series	2,350±50
M-4 Series	1,950 ± 50

CAUTION

- Do not operate the water pump in a dry sump. Operating the water pump with a dry sump will result in water pump component damage and reduced service life.
- Do not engage/disengage the water pump above LOW IDLE. Engaging/disengaging the water pump above low idle will result in water pump component damage and reduced service life.
- Limit water pump operation to 2.5 minutes when in a no-flow condition (not flowing water through spray heads, dump bar, water cannon, drain valve or hose reel). Water pump operation in a no flow condition will cause overheating of the water pump and damage to the shaft bearings and seals.
- Avoid any sudden stoppage of water pump e.g.; disengaging water pump above LOW IDLE. Stopping pump suddenly above LOW IDLE will result in shaft, impeller and drive motor damage.

If water pump rpm is out of the desired range, adjust the water pump hydraulic drive motor flow control valve to obtain specified rpm.

CAUTION

Water pump rpm must not exceed the specifications listed below with engine at HIGH IDLE. Failure to ensure water pump speed is at or below specifications will result in reduced spray system component service life.

NOTE

The suction loading pump has a maximum vertical lift capability of 8 feet. Attempting to pump water into the tank from a reservoir that is more than 8 feet below the pump station will result in reduced suction loading performance.

SECTION 3

Limitations

SECTION 4

Normal Operations

Contents

Description.....4-1	After Operations..... 4-8
Before Operations.....4-1	Cold Weather Operations And Storage.....4-8
Operations.....4-2	Unit Reactivation4-9

DESCRIPTION

This section provides the vehicle operator with step by step operating procedures for the installed system. The information is separated into before operations, operations and after operations.

A pocket size Operator’s Checklist of all MAC/MTT procedures is in the Ops-1 Appendix for use in the vehicle cab.

NOTE

Place a copy of the Ops-1 Appendix Operator’s Checklist within the cab for daily use.

BEFORE OPERATIONS

These procedures are used to perform a walk-around inspection of the MEGA water tanker system before use or the beginning of a shift. This inspection is in addition to and does not replace the vehicle manufacturer’s inspection requirements.

1. Chocks – AS REQUIRED
2. Vehicle parking brake – ON
3. Cab control switches – OFF
4. Foam concentrate level – CHECKED
 - a. Level should be at least 1” from the top of the foam tank.

WARNING

Ensure PPE fall arrest harness is worn, adjusted properly and attached to an anchor point. Failure to use PPE properly may result in personnel injury or death.

5. Water cannon – INSPECT FOR SECURITY, DAMAGE & LEAKS
 - a. Nozzle – Check for security and kinking of foam concentrate supply line.
6. Solenoid control box – INSPECT FOR SECURITY, DAMAGE & LEAKS
7. Tanker front mounts – INSPECT FOR SECURITY & DAMAGE
8. Vehicle hydraulic tank – SERVICED
9. Tanker LH hydraulic hoses and cabling – INSPECT FOR SECURITY, DAMAGE & LEAKS
10. Chassis pivot bore pins – INSTALLED AND SECURED
11. Tank drain petcocks – CLOSED
12. Spray heads – SECURED & ADJUSTED FOR APPLICATION
13. Water pump assembly – INSPECT
 - a. Water pump – Check to ensure volute case drain valve is closed.
 - b. Water pump and drive motor for evidence of overheating.
14. Hose reel – INSPECT FOR SECURITY, DAMAGE & LEAKS
15. Tanker RH hydraulic hosing & cabling – INSPECT FOR SECURITY, DAMAGE AND LEAKS
16. Front bumper spray heads & plumbing – SECURED AND SET

SECTION 4

Normal Operations

OPERATIONS

Use these procedures to safely operate the standard and optional systems installed on the MEGA water tanker. Note that some operations are applicable to DiSCS® only.

CAUTION

Limit water pump operation to 2.5 minutes when in a no-flow condition (not flowing water through spray heads, dump bar, monitor, drain valve or hose reel). Water pump operation in a no flow condition will cause overheating of the water pump and damage to the shaft bearings and seals.

Spray Head System

NOTE

Operating more than 4 spray heads simultaneously will greatly reduce the width and flow of active spray heads.

1. Cab control system/power switch – ON
2. Pump switch – ON

CAUTION

Do not engage/disengage the water pump above LOW IDLE. Engaging/disengaging the water pump above low idle will result in water pump component damage and reduced service life.

3. Individual spray heads – SELECTED AS REQUIRED

Once operations are complete:

4. Pump switch – OFF

CAUTION

Do not engage/disengage the water pump above LOW IDLE. Engaging/disengaging the water pump above low idle will result in water pump component damage and reduced service life.

5. Cab control system/power switch – OFF

Time Based Mode (Banding)

Operator can cycle on/off periods of spray using selected time intervals. Refer to Section 2 - DiSCS® "Time Based Program Mode" for complete operation details.

1. Cab control power switch – ON
2. Intermittent – SET AS REQUIRED
 - a. Timer on/off (wet/dry) – SET AS REQUIRED
3. Pump switch – ON

CAUTION

Do not engage/disengage the water pump above LOW IDLE. Engaging/disengaging the water pump above low idle will result in water pump component damage and reduced service life.

4. Individual spray heads or dump bar– SELECTED AS REQUIRED

Once operations are complete:

5. Pump switch – OFF

CAUTION

Do not engage/disengage the water pump above LOW IDLE. Engaging/disengaging the water pump above low idle will result in water pump component damage and reduced service life.

6. Spray head/dump bar - OFF
7. Cab control system/power switch – OFF

Distance Based Mode (Checkerboard) (DiSCS®)

Operator can select alternating intermittent watering pattern that is dependent on distance traveled. Requires functioning GPS. Refer to Section 2 - DiSCS® "Distance Based Program Mode" for complete operation details.

1. Cab control power switch – ON
2. Distance based program mode – SELECTED
 - a. Wait for GPS lock - SWITCH LED GREEN
 - b. Wet/Dry intervals – SELECTED AS REQUIRED

SECTION 4

Normal Operations

- Pump switch – ON

CAUTION

Do not engage/disengage the water pump above LOW IDLE. Engaging/disengaging the water pump above low idle will result in water pump component damage and reduced service life.

- Individual spray heads – SELECTED AS REQUIRED

Once operations are complete:

- Spray heads - OFF
- Pump switch – OFF

CAUTION

Do not engage/disengage the water pump above LOW IDLE. Engaging/disengaging the water pump above low idle will result in water pump component damage and reduced service life.

- Cab control system/power switch – OFF

Speed Based Mode (Continuous Rate) (DiSCS®)

Operator can select an intermittent spray operation which provides a continuous rate of water application based on the speed traveled. Refer to *Section 2 - DiSCS® "Speed Based Program Mode"* for complete operation details.

- Cab control power switch – ON
- Speed based program mode – SELECTED
 - Wait for GPS lock
 - Wet (coverage percentage)/Dry (maximum speed) intervals – SELECTED AS REQUIRED
- Pump switch – ON

CAUTION

Do not engage/disengage the water pump above LOW IDLE. Engaging/disengaging the water pump above low idle will result in water pump component damage and reduced service life.

- Individual spray heads – SELECTED AS REQUIRED

Once operations are complete:

- Spray heads - OFF
- Pump switch – OFF

CAUTION

Do not engage/disengage the water pump above LOW IDLE. Engaging/disengaging the water pump above low idle will result in water pump component damage and reduced service life.

- Cab control system/power switch - OFF

Dump Bar

- Cab control system/power switch – ON
- Intermittent – SET AS REQUIRED
 - Timer on/off (wet/dry) – SET AS REQUIRED
- Pump switch (pressure bar only)– ON

CAUTION

Do not engage/disengage the water pump above LOW IDLE. Engaging/disengaging the water pump above low idle will result in water pump component damage and reduced service life.

- Dump bar switch – ON

Once operations are complete:

- Dump Bar - OFF
- Pump switch – OFF

CAUTION

Do not engage/disengage the water pump above LOW IDLE. Engaging/disengaging the water pump above low idle will result in water pump component damage and reduced service life.

- Cab control system/power switch – OFF

SECTION 4

Normal Operations

Water Cannon

1. Cab control system/power switch – ON
2. Pump switch – ON

CAUTION

Do not engage/disengage the water pump above LOW IDLE. Engaging/disengaging the water pump above low idle will result in water pump component damage and reduced service life.

3. **(Multi water cannon)** Select desired water cannon to control. Only one water cannon can be controlled at any given time.

NOTE

- After initial start-up, desired canon (1, 2, or 3) must be selected.
 - The joystick controls will be inactive for 4 seconds while switching between controlling different water cannons.
 - Some units are equipped with two or three water cannons. Auxiliary water cannons can be mounted to VSS pipping or vehicle front bumper. Additional switches are provided to select between the primary and auxiliary water cannons. The joystick box will operate the selected water cannon.
4. Water cannon – POINTED IN A SAFE DIRECTION
 5. Monitor/BFV switch – ON
 6. Water cannon joystick – AS REQUIRED
 7. Monitor/BFV switch – OFF

Once operations are complete:

8. Water cannon nozzle - STOW

CAUTION

Manual and remote adjustable nozzles must be stowed pointing vertically to reduce wear on water cannon joints. Leaving the nozzle in any other position will cause increased wear on water cannon joints and result in premature joint failure.

NOTE

If equipped with **multi water cannons**, STOW each nozzle.

9. Pump switch – OFF

CAUTION

Do not engage/disengage the water pump above LOW IDLE. Engaging/disengaging the water pump above low idle will result in water pump component damage and reduced service life.

10. Cab control system/power switch – OFF

Fire Suppression System

1. Cab control system/power switch – ON
2. Pump switch – ON

CAUTION

Do not engage/disengage the water pump above LOW IDLE. Engaging/disengaging the water pump above low idle will result in water pump component damage and reduced service life.

3. Water Cannon – POINTED IN A SAFE DIRECTION

SECTION 4

Normal Operations

4. Foam switch – ON

CAUTION

(If equipped with multi water cannons) Ensure that the foam switch is OFF before operating a different water cannon. Operating a water cannon with the foam switch on will cause damage to the water cannon and hydraulics.

5. Monitor/BFV switch – ON
6. Water cannon joystick – AS REQUIRED

Once operations are complete:

7. Foam switch – OFF
8. Water cannon – PURGED OF FOAM
a. Flow water through the monitor nozzle with the **foam switch off** to flush foam from the nozzle.
9. Monitor/BFV switch – OFF
10. Water cannon nozzle – STOW

CAUTION

Manual and remote adjustable nozzles must be stowed pointing vertically to reduce wear on water cannon joints. Leaving the nozzle in any other position will cause increased wear on water cannon joints and result in premature joint failure.

NOTE

If equipped with **multi water cannons**, STOW each nozzle.

11. Pump switch – OFF

CAUTION

Do not engage/disengage the water pump above LOW IDLE. Engaging/disengaging the water pump above low idle will result in water pump component damage and reduced service life.

12. Cab control system/power switch – OFF

13. Vehicle – WASH OR FRESH WATER RINSE
a. Ensure areas exposed to foam spray are clean.

Tank Drain

NOTE

Pump switch ON is only required for pressurized tank drain option.

1. Cab control system/power switch – ON
2. Pump switch (pressure drain only)– ON

CAUTION

Do not engage/disengage the water pump above LOW IDLE. Engaging/disengaging the water pump above low idle will result in water pump component damage and reduced service life.

3. Drain switch – ON
4. Water level – AS REQUIRED

CAUTION

Do not operate the water pump in a dry sump. Dry operation will result in shaft seal damage.

Once operations are complete:

5. Drain switch – OFF
6. Pump switch – OFF

CAUTION

Do not engage/disengage the water pump above LOW IDLE. Engaging/disengaging the water pump above low idle will result in water pump component damage and reduced service life.

7. Cab control system/power switch – OFF

SECTION 4

Normal Operations

Hose Reel

1. Hose nozzle – CLOSED
2. Hose – DEPLOY DESIRED LENGTH
3. Gate valve – OPEN
4. Cab control system/power switch – ON
5. Pump switch – ON
6. Hose reel switch (DiSCS®)– ON

CAUTION

Do not engage/disengage the water pump above LOW IDLE. Engaging/disengaging the water pump above low idle will result in water pump component damage and reduced service life.

7. Vehicle rpm – SET
8. Hose nozzle – OPEN AS REQUIRED

Once operations are complete:

9. Hose nozzle – CLOSED
10. Vehicle rpm – LOW IDLE
11. Hose reel switch (DiSCS®)– OFF
12. Pump switch – OFF

CAUTION

Do not engage/disengage the water pump above LOW IDLE. Engaging/disengaging the water pump above low idle will result in water pump component damage and reduced service life.

13. Cab control system/power switch- OFF
14. Gate valve – CLOSED
15. Hose – DRAINED AND STOWED

Water Circulation System

1. Tanker – FULL
2. Chassis – LOW IDLE
3. Cab control system/power switch – ON.
4. Pump switch – ON

CAUTION

Do not engage/disengage the water pump above LOW IDLE. Engaging/disengaging the water pump above low idle will result in water pump component damage and reduced service life.

5. Circulation valve – OPEN
 - a. Opens BFV that allows water pressure to mix water tank contents

NOTE

Keep the switch ON until water cannon or spray system is used to flow the water mixture. If switch is left ON, circulation system will significantly reduce water cannon reach.

Once operations are complete:

6. Circulation valve – CLOSED
7. Pump switch – OFF
8. Cab control system/power switch – OFF

Suction Load Station

1. Water supply – ACCESSIBLE
2. Chassis – SECURED AND SAFE FOR EXITING
3. Foot valve – INSPECT FOR SECURITY & DAMAGE
4. Suction hoses – INSPECT FOR DAMAGE
 - a. Ensure suction hoses are connected properly to each other and the suction load inlet to prevent air leaks while in use.
5. Suction hoses – IMMersed IN WATER SUPPLY

SECTION 4

Normal Operations

6. **(M3 configured tankers)** Position all butterfly valves as indicated in the following pictures and in the order as follows:
 - a. Sump valve - **CLOSE**
 - b. Suction valve - **OPEN**
 - c. Spray bar valve - **CLOSE**
 - d. Tank fill valve - **OPEN**

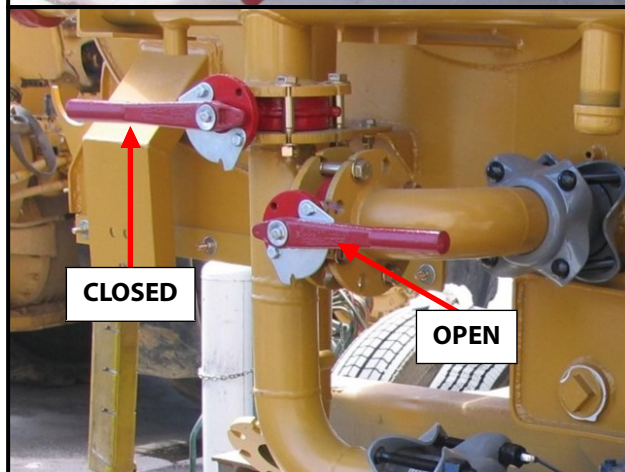
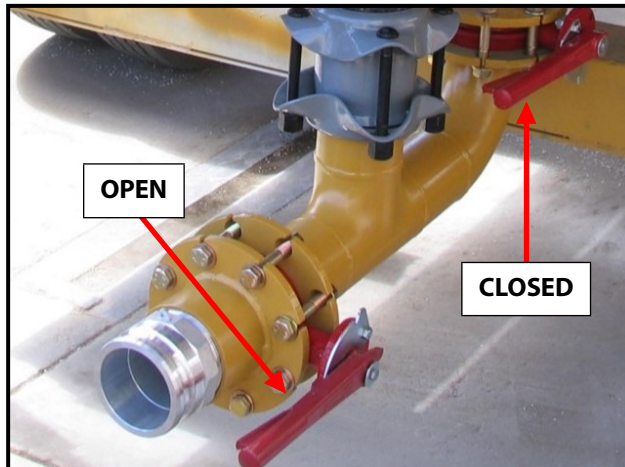

NOTE

Opening and closing valves in this sequence allows the water in the suction loading sump built inside of the tank to flood the water pump and suction hose. This will allow water pump to lift water from water source.

7. Water pump and suction hoses – PRIMED

CAUTION

Do not operate the water pump in a dry sump. Dry operation will result in shaft seal damage.

8. Foot valve – SUBMERGED
9. **(M4 configured tankers)** Diversion valve handle – SUCTION LOAD POSITION
10. Chassis – LOW IDLE
11. Cab control system/power switch – ON.
12. **(DiSCS®)** Suction load switch – ON
13. Pump switch – ON

CAUTION

Do not engage/disengage the water pump above LOW IDLE. Engaging/disengaging the water pump above low idle will result in water pump component damage and reduced service life.

14. Chassis – HIGH IDLE

Once operations are complete:

15. Chassis – LOW IDLE
16. **(DiSCS®)** Suction load switch – OFF
17. Pump switch – OFF

CAUTION

Do not engage/disengage the water pump above LOW IDLE. Engaging/disengaging the water pump above low idle will result in water pump component damage and reduced service life.

18. Cab control system/power switch – OFF
19. Chassis – OFF
20. **(M3 configured tankers)** Reposition all valves for spraying water as follows:
 - a. Suction valve - **CLOSE**
 - b. Sump valve - **OPEN**
 - c. Tank fill valve - **CLOSE**
 - d. Spray bar valve - **OPEN**

21. Suction hoses – DRAINED AND STOWED

SECTION 4

Normal Operations

22.(M4 configured tankers) Diversion valve handle – WATER PUMP POSITION

COLD WEATHER OPERATIONS AND STORAGE

AFTER OPERATIONS

These procedures are used to perform a walk-around inspection after using the MEGA water tanker systems. This inspection is in addition to and does not replace the vehicle manufacturer's inspection requirements.

1. Vehicle park brake – ON
2. Cab control switches – OFF
3. Chocks – AS REQUIRED
4. Water cannon – INSPECT FOR SECURITY & DAMAGE
5. Vehicle hydraulic tank - SERVICE AS REQUIRED
6. Tank lines and hoses – INSPECT FOR SECURITY, DAMAGE & LEAKS
7. Tank drains – AS REQUIRED
8. Spray heads – SECURED & SET
9. Water pump – INSPECT FOR SECURITY, DAMAGE & LEAKS
10. Hose reel – INSPECT FOR SECURITY, DAMAGE & LEAKS
11. Solenoid control box – INSPECT FOR SECURITY, DAMAGE & LEAKS

CAUTION

Ensure all water is drained from system when the temperatures are expected to fall below 4.4°C (40°F) for any period of time. Failure to ensure all systems are drained and free from standing water will result in ice formation, which will cause serious damage to shaft, operator, diaphragm, drive motor, water pump, or butterfly valve.

To ensure all water is drained from tank, complete the following:

1. Drain the tank using an appropriate method until the water level gauge reads **empty**.
2. Tanker – PARKED
 - a. Slight nose up angle to allow water to flow to the rear of the tank.
3. All drains (water pump, suction load pump, rear spray bar, front spray bar, etc.) – OPEN
4. Water pump sump cover – REMOVED
5. Chassis – LOW IDLE
6. Cab control system/power switch – ON
7. Monitor/BFV switch – ON
8. Water Cannon Nozzle – FULLY DOWN

CAUTION

If equipped with **multi water cannons**, point each nozzle fully DOWN and OPEN each BFV to drain water from system or damage may occur to components.

9. Dump bar switch – ON
10. Drain switch – ON
11. Cab control system/power switch – OFF

SECTION 4

Normal Operations

12. Chassis – OFF
13. Hose reel – DRAIN
 - a. Hose – UNWIND
 - b. Nozzle – FULLY OPEN
 - c. Gate valve – OPEN
 - d. Allow water to drain.
 - e. Hose – REWIND
 - f. Gate valve – CLOSED
 - g. Nozzle – CLOSED
14. Verify **all** water is drained.

UNIT REACTIVATION

1. Water pump bearings – LUBRICATE
 - a. See MX-2 maintenance manual for instructions.
2. Tank interior/coating – INSPECT
 - a. Free of damage and debris.
 - b. Interior coating (if applicable) for damage.
 - c. Clean or repair as required.
3. Sump cover(s) – INSTALL
 - a. Install **new** gasket(s).
4. Tank drains and petcocks – CLOSED
5. Chassis - LOW IDLE
6. Control system/power switch – ON
7. Individual spray head switches – OFF
8. Dump bar switch – OFF
9. Drain switch – OFF
10. Monitor/BFV switch – OFF
11. Cab control system/power switch – OFF
12. Chassis – OFF

SECTION 4

Normal Operations

SECTION 5 Performance

Contents

Spray Pattern And Reach (Typical).....	5-1	Precision Watering.....	5-3
Typical Spray Distance.....	5-1	Fire Suppression System	5-12
Typical Spray Duration and Flow.....	5-2		

SPRAY PATTERN AND REACH (TYPICAL)

The figures below illustrate the typical width and reach of spray heads and water cannon. Typical spray head deflector fan adjustments are also depicted.

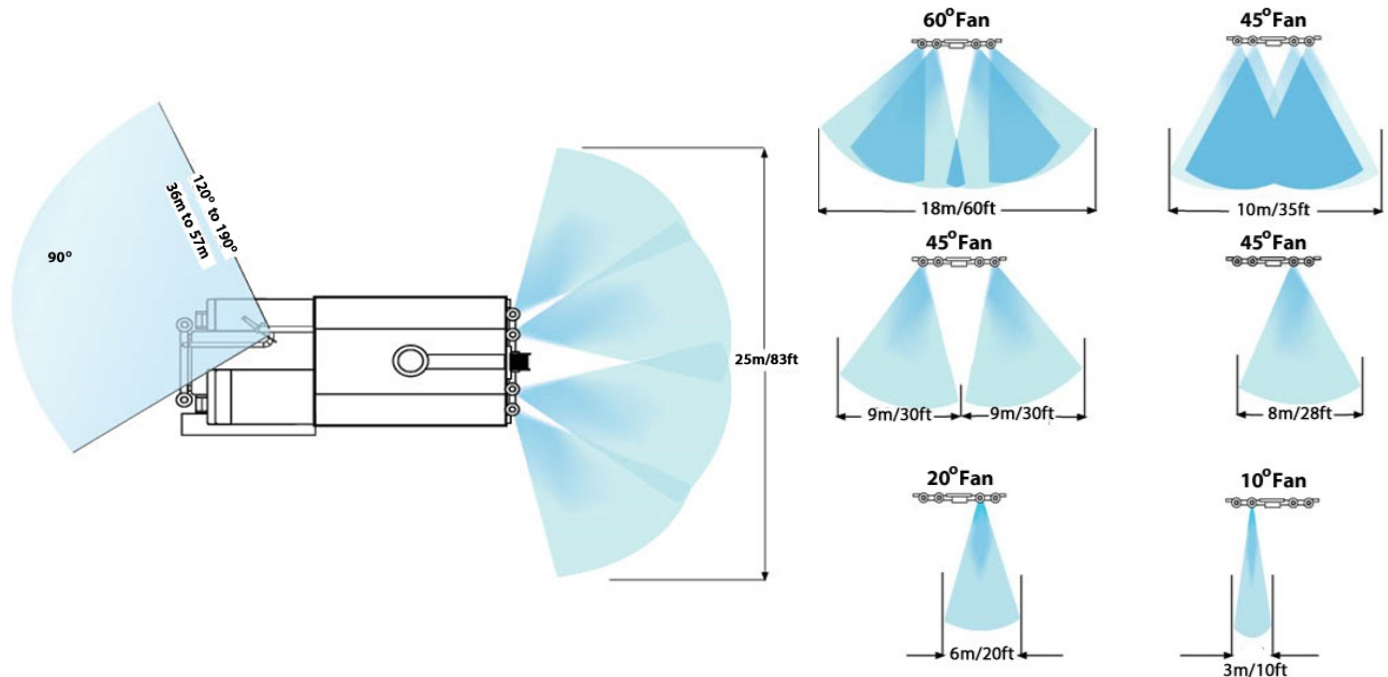

TYPICAL SPRAY DISTANCE

The table below contains a standard vehicle spray duration based on spray head deflector opening, vehicle speed and 75,708 liter (20,000 gallon) capacity.

Number of Spray Heads and Opening Height	LPM/GPM	Ground Speed (KPH/MPH)	Max. Distance (Km./Miles)
2 Spray Heads, Fine Spray (1/4" Slot Height)	3611/954	16/10	5.6/3.5
2 Spray Heads, Fine Spray (1/4" Slot Height)	3611/954	24/15	8.3/5.2
2 Spray Heads, Heavy Spray (3/8" Slot Height)	4705/1243	16/10	4.3/2.7
2 Spray Heads, Heavy Spray (3/8" Slot Height)	4705/1243	24/15	6.4/4.0
4 Spray heads, Fine Spray (1/4" Slot Height)	5693/1504	16/10	3.5/2.2
4 Spray heads, Fine Spray (1/4" Slot Height)	5693/1504	24/15	5.3/3.3
4 Spray heads, Heavy Spray (3/8" Slot Height)	5950/1572	16/10	3.3/2.1
4 Spray heads, Heavy Spray (3/8" Slot Height)	5950/1572	24/15	5.1/3.2

SECTION 5 Performance

TYPICAL SPRAY DURATION AND FLOW

Duration

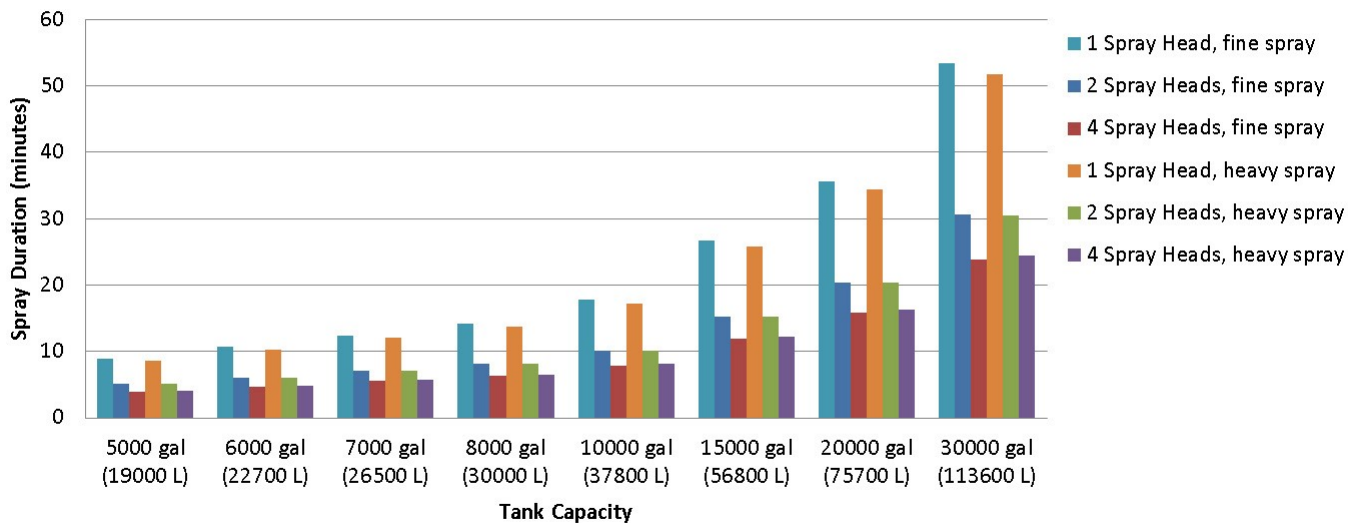

Estimated spray duration for various capacity tanks with four different spray head configurations. Spray duration in minutes is shown on the vertical axis. The ‘fine’ setting is 1/4 inches in height, and the ‘heavy’ setting is 3/8 inches in height.

Flow Rates

Spray Head Configuration Flow Rates

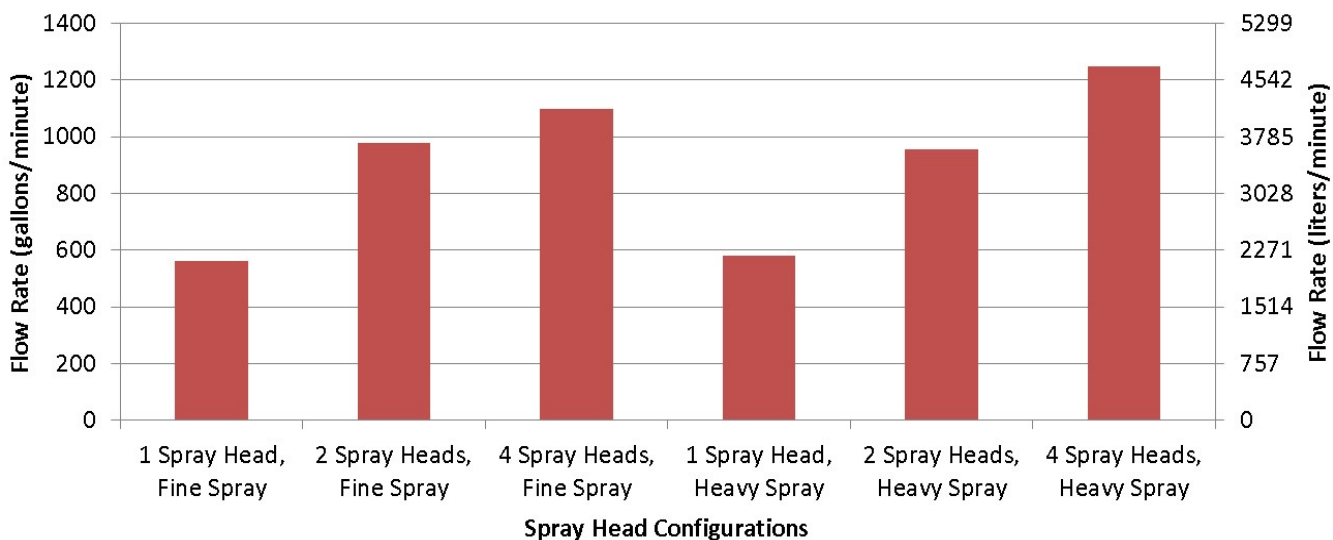

Total flow rates of different spray head configurations. The approximate total flow rates in gallons/minute (left vertical axis) and liters/minute (right vertical axis) of four possible spray head configurations. The ‘fine’ setting is 1/4 inches in height, and the ‘heavy’ setting is 3/8 inches in height.

SECTION 5 Performance

PRECISION WATERING

The following tables provide precision watering calculations for the installed spray system. Each table is categorized by size of spray head deflector opening at a full fan width for 2 or 4 spray heads.

FINE SPRAY (1/4" SLOT HEIGHT) & FULL FAN (34,068 lit/9,000 gal TANK)

SPEED		2 SPRAY HEADS (FLOW 3611 lpm/954 gpm)				4 SPRAY HEADS (FLOW 5693 lpm/1504 gpm)				
		SPRAY DISTANCE	TOTAL COVERAGE	DISPERSAL	WATER LAYER	MAX DISTANCE	TOTAL COVERAGE	DISPERSAL	WATER LAYER	
		(FT)	(SQ FT)	(GAL/SQ FT)	(IN/SQ FT)	(FT)	(SQ FT)	(GAL/SQ FT)	(IN/SQ FT)	
U S	MPH	FPM								
	2	176	1660	137811	0.065	0.105	1053	78989	0.114	0.183
	5	440	4151	344528	0.026	0.042	2633	197473	0.046	0.073
	10	880	8302	689057	0.013	0.021	5266	394947	0.023	0.037
	15	1320	12453	1033585	0.009	0.014	7899	592420	0.015	0.024
M E T R I C	KPM	MPM	(METER)	(M SQ)	(L/M SQ)	(MM)	(METERS)	(M SQ)	(M/M SQ)	(MM)
	3	53	500	12501	2.725	2.67	317	7295	4.670	4.65
	8	134	1264	31606	1.078	1.07	802	18443	1.847	1.84
	16	268	2528	63211	0.539	0.53	1604	36887	0.924	0.94
	24	402	3793	94817	0.359	0.35	2406	55330	0.616	0.61

HEAVY SPRAY (3/8" SLOT HEIGHT) & FULL FAN (34,068 lit/9,000 gal TANK)

SPEED		2 SPRAY HEADS (FLOW 4705 lpm/1243 gpm)				4 SPRAY HEADS (FLOW 5950 lpm/1572 gpm)				
		SPRAY DISTANCE	TOTAL COVERAGE	DISPERSAL	WATER LAYER	MAX DISTANCE	TOTAL COVERAGE	DISPERSAL	WATER LAYER	
		(FT)	(SQ FT)	(GAL/SQ FT)	(IN/SQ FT)	(FT)	(SQ FT)	(GAL/SQ FT)	(IN/SQ FT)	
U S	MPH	FPM								
	2	176	1274	99398	0.091	0.145	1008	65496	0.137	0.220
	5	440	3186	248496	0.036	0.058	2519	163740	0.055	0.088
	10	880	6372	496991	0.018	0.029	5038	327481	0.027	0.044
	15	1320	9558	745487	0.012	0.019	7557	491221	0.018	0.029
M E T R I C	KPM	MPM	(METER)	(M SQ)	(L/M SQ)	(MM)	(METERS)	(M SQ)	(M/M SQ)	(MM)
	3	53	384	9210	3.699	3.68	303	6069	5.613	5.59
	8	134	970	23286	1.463	1.47	767	15345	2.220	2.23
	16	268	1941	46573	0.731	0.74	1534	30690	1.110	1.11
	24	402	2911	69859	0.488	0.48	2302	46035	0.740	0.74

SECTION 5 Performance

FINE SPRAY (1/4" SLOT HEIGHT) & FULL FAN (41639 lit/11,000 gal TANK)

SPEED		2 SPRAY HEADS (FLOW 3611 lpm/954 gpm)				4 SPRAY HEADS (FLOW 5693 lpm/1504 gpm)				
		SPRAY DISTANCE	TOTAL COVERAGE	DISPERSAL	WATER LAYER	MAX DISTANCE	TOTAL COVERAGE	DISPERSAL	WATER LAYER	
		(FT)	(SQ FT)	(GAL/SQ FT)	(IN/SQ FT)	(FT)	(SQ FT)	(GAL/SQ FT)	(IN/SQ FT)	
MPH	FPM									
U S	2	176	2029	168436	0.065	0.105	1287	96543	0.114	0.183
	5	440	5073	421090	0.026	0.042	3218	241356	0.046	0.073
	10	880	10147	842180	0.013	0.021	6436	482713	0.023	0.037
	15	1320	15220	1263270	0.009	0.014	9654	724069	0.015	0.024
M E T R I C	KPM	MPM	(METER)	(M SQ)	(L/M SQ)	(MM)	(METERS)	(M SQ)	(M/M SQ)	(MM)
	3	53	611	15279	2.725	2.67	388	8916	4.670	4.65
	8	134	1545	38629	1.078	1.07	980	22542	1.847	1.84
	16	268	3090	77259	0.539	0.53	1960	45084	0.924	0.94
	24	402	4636	115888	0.359	0.35	2940	67626	0.616	0.61

HEAVY SPRAY (3/8" SLOT HEIGHT) & FULL FAN (41639 lit/11,000 gal TANK)

SPEED		2 SPRAY HEADS (FLOW 4705 lpm/1243 gpm)				4 SPRAY HEADS (FLOW 5950 lpm/1572 gpm)				
		SPRAY DISTANCE	TOTAL COVERAGE	DISPERSAL	WATER LAYER	MAX DISTANCE	TOTAL COVERAGE	DISPERSAL	WATER LAYER	
		(FT)	(SQ FT)	(GAL/SQ FT)	(IN/SQ FT)	(FT)	(SQ FT)	(GAL/SQ FT)	(IN/SQ FT)	
MPH	FPM									
U S	2	176	1558	121487	0.091	0.145	1232	80051	0.137	0.220
	5	440	3894	303717	0.036	0.058	3079	200127	0.055	0.088
	10	880	7788	607434	0.018	0.029	6158	400254	0.027	0.044
	15	1320	11681	911150	0.012	0.019	9237	600382	0.018	0.029
M E T R I C	KPM	MPM	(METER)	(M SQ)	(L/M SQ)	(MM)	(METERS)	(M SQ)	(M/M SQ)	(MM)
	3	53	469	11257	3.699	3.68	371	7418	5.613	5.59
	8	134	1186	28461	1.463	1.47	938	18755	2.220	2.23
	16	268	2372	56923	0.731	0.74	1876	37510	1.110	1.11
	24	402	3558	85384	0.488	0.48	2813	56265	0.740	0.74

SECTION 5 Performance

FINE SPRAY (1/4" SLOT HEIGHT) & FULL FAN (49,210 lit/13,000 gal TANK)

SPEED		2 SPRAY HEADS (FLOW 3611 lpm/954 gpm)				4 SPRAY HEADS (FLOW 5693 lpm/1504 gpm)				
		SPRAY DISTANCE	TOTAL COVERAGE	DISPERSAL	WATER LAYER	MAX DISTANCE	TOTAL COVERAGE	DISPERSAL	WATER LAYER	
		(FT)	(SQ FT)	(GAL/SQ FT)	(IN/SQ FT)	(FT)	(SQ FT)	(GAL/SQ FT)	(IN/SQ FT)	
MPH	FPM									
U S	2	176	2398	199061	0.065	0.105	1521	114096	0.114	0.183
	5	440	5996	497652	0.026	0.042	3803	285239	0.046	0.073
	10	880	11992	995304	0.013	0.021	7606	570479	0.023	0.037
	15	1320	17987	1492956	0.009	0.014	11410	855718	0.015	0.024
M E T R I C	KPM	MPM	(METER)	(M SQ)	(L/M SQ)	(MM)	(METERS)	(M SQ)	(M/M SQ)	(MM)
	3	53	722	18057	2.725	2.67	458	10537	4.670	4.65
	8	134	1826	45653	1.078	1.07	1158	26641	1.847	1.84
	16	268	3652	91306	0.539	0.53	2317	53281	0.924	0.94
	24	402	5478	136959	0.359	0.35	3475	79922	0.616	0.61

HEAVY SPRAY (3/8" SLOT HEIGHT) & FULL FAN (49,210 lit/13,000 gal TANK)

SPEED		2 SPRAY HEADS (FLOW 4705 lpm/1243 gpm)				4 SPRAY HEADS (FLOW 5950 lpm/1572 gpm)				
		SPRAY DISTANCE	TOTAL COVERAGE	DISPERSAL	WATER LAYER	MAX DISTANCE	TOTAL COVERAGE	DISPERSAL	WATER LAYER	
		(FT)	(SQ FT)	(GAL/SQ FT)	(IN/SQ FT)	(FT)	(SQ FT)	(GAL/SQ FT)	(IN/SQ FT)	
MPH	FPM									
U S	2	176	1841	143575	0.091	0.145	1455	94606	0.137	0.220
	5	440	4602	358938	0.036	0.058	3639	236514	0.055	0.088
	10	880	9204	717876	0.018	0.029	7277	473028	0.027	0.044
	15	1320	13805	1076814	0.012	0.019	10916	709542	0.018	0.029
M E T R I C	KPM	MPM	(METER)	(M SQ)	(L/M SQ)	(MM)	(METERS)	(M SQ)	(M/M SQ)	(MM)
	3	53	554	13304	3.699	3.68	438	8767	5.613	5.59
	8	134	1402	33636	1.463	1.47	1108	22165	2.220	2.23
	16	268	2803	67273	0.731	0.74	2217	44330	1.110	1.11
	24	402	4205	100909	0.488	0.48	3325	66496	0.740	0.74

SECTION 5 Performance

FINE SPRAY (1/4" SLOT HEIGHT) & FULL FAN (56,781 lit/15,000 gal TANK)

SPEED		2 SPRAY HEADS (FLOW 3611 lpm/954 gpm)				4 SPRAY HEADS (FLOW 5693 lpm/1504 gpm)				
		SPRAY DISTANCE	TOTAL COVERAGE	DISPERSAL	WATER LAYER	MAX DISTANCE	TOTAL COVERAGE	DISPERSAL	WATER LAYER	
		(FT)	(SQ FT)	(GAL/SQ FT)	(IN/SQ FT)	(FT)	(SQ FT)	(GAL/SQ FT)	(IN/SQ FT)	
MPH	FPM									
U S	2	176	2767	229686	0.065	0.105	1755	131649	0.114	0.183
	5	440	6918	574214	0.026	0.042	4388	329122	0.046	0.073
	10	880	13836	1148428	0.013	0.021	8777	658245	0.023	0.037
	15	1320	20755	1722642	0.009	0.014	13165	987367	0.015	0.024
M E T R I C	KPM	MPM	(METER)	(M SQ)	(L/M SQ)	(MM)	(METERS)	(M SQ)	(M/M SQ)	(MM)
	3	53	833	20835	2.725	2.67	529	12158	4.670	4.65
	8	134	2107	52677	1.078	1.07	1336	30739	1.847	1.84
	16	268	4214	105354	0.539	0.53	2673	61479	0.924	0.94
24	402	6321	158031	0.359	0.35	4009	92218	0.616	0.61	

HEAVY SPRAY (3/8" SLOT HEIGHT) & FULL FAN (56,781 lit/15,000 gal TANK)

SPEED		2 SPRAY HEADS (FLOW 4705 lpm/1243 gpm)				4 SPRAY HEADS (FLOW 5950 lpm/1572 gpm)				
		SPRAY DISTANCE	TOTAL COVERAGE	DISPERSAL	WATER LAYER	MAX DISTANCE	TOTAL COVERAGE	DISPERSAL	WATER LAYER	
		(FT)	(SQ FT)	(GAL/SQ FT)	(IN/SQ FT)	(FT)	(SQ FT)	(GAL/SQ FT)	(IN/SQ FT)	
MPH	FPM									
U S	2	176	2124	165664	0.091	0.145	1679	109160	0.137	0.220
	5	440	5310	414159	0.036	0.058	4198	272901	0.055	0.088
	10	880	10619	828319	0.018	0.029	8397	545802	0.027	0.044
	15	1320	15929	1242478	0.012	0.019	12595	818702	0.018	0.029
M E T R I C	KPM	MPM	(METER)	(M SQ)	(L/M SQ)	(MM)	(METERS)	(M SQ)	(M/M SQ)	(MM)
	3	53	640	15351	3.699	3.68	506	10116	5.613	5.59
	8	134	1617	38811	1.463	1.47	1279	25575	2.220	2.23
	16	268	3234	77623	0.731	0.74	2558	51151	1.110	1.11
24	402	4851	116434	0.488	0.48	3836	76726	0.740	0.74	

SECTION 5 Performance

FINE SPRAY (1/4" SLOT HEIGHT) & FULL FAN (75,708 lit/20,000 gal TANK)

SPEED		2 SPRAY HEADS (FLOW 3611 lpm/954 gpm)				4 SPRAY HEADS (FLOW 5693 lpm/1504 gpm)				
		SPRAY DISTANCE	TOTAL COVERAGE	DISPERSAL	WATER LAYER	MAX DISTANCE	TOTAL COVERAGE	DISPERSAL	WATER LAYER	
		(FT)	(SQ FT)	(GAL/SQ FT)	(IN/SQ FT)	(FT)	(SQ FT)	(GAL/SQ FT)	(IN/SQ FT)	
MPH	FPM									
U S	2	176	3690	306247	0.065	0.105	2340	175532	0.114	0.183
	5	440	9224	765618	0.026	0.042	5851	438830	0.046	0.073
	10	880	18449	1531237	0.013	0.021	11702	877660	0.023	0.037
	15	1320	27673	2296855	0.009	0.014	17553	1316489	0.015	0.024
M E T R I C	KPM	MPM	(METER)	(M SQ)	(L/M SQ)	(MM)	(METERS)	(M SQ)	(M/M SQ)	(MM)
	3	53	1111	27780	2.725	2.67	705	16211	4.670	4.65
	8	134	2809	70236	1.078	1.07	1782	40986	1.847	1.84
	16	268	5619	140472	0.539	0.53	3564	81972	0.924	0.94
	24	402	8428	210708	0.359	0.35	5346	122957	0.616	0.61

HEAVY SPRAY (3/8" SLOT HEIGHT) & FULL FAN (75,708 lit/20,000 gal TANK)

SPEED		2 SPRAY HEADS (FLOW 4705 lpm/1243 gpm)				4 SPRAY HEADS (FLOW 5950 lpm/1572 gpm)				
		SPRAY DISTANCE	TOTAL COVERAGE	DISPERSAL	WATER LAYER	MAX DISTANCE	TOTAL COVERAGE	DISPERSAL	WATER LAYER	
		(FT)	(SQ FT)	(GAL/SQ FT)	(IN/SQ FT)	(FT)	(SQ FT)	(GAL/SQ FT)	(IN/SQ FT)	
MPH	FPM									
U S	2	176	2832	220885	0.091	0.145	2239	145547	0.137	0.220
	5	440	7080	552212	0.036	0.058	5598	363868	0.055	0.088
	10	880	14159	1104425	0.018	0.029	11196	727735	0.027	0.044
	15	1320	21239	1656637	0.012	0.019	16794	1091603	0.018	0.029
M E T R I C	KPM	MPM	(METER)	(M SQ)	(L/M SQ)	(MM)	(METERS)	(M SQ)	(M/M SQ)	(MM)
	3	53	853	20468	3.699	3.68	674	13487	5.613	5.59
	8	134	2156	51749	1.463	1.47	1705	34100	2.220	2.23
	16	268	4312	103497	0.731	0.74	3410	68201	1.110	1.11
	24	402	6469	155246	0.488	0.48	5115	102301	0.740	0.74

SECTION 5 Performance

FINE SPRAY (1/4" SLOT HEIGHT) & FULL FAN (113562 lit/30,000 gal TANK)

SPEED		2 SPRAY HEADS (FLOW 3611 lpm/954 gpm)				4 SPRAY HEADS (FLOW 5693 lpm/1504 gpm)				
		SPRAY DISTANCE	TOTAL COVERAGE	DISPERSAL	WATER LAYER	MAX DISTANCE	TOTAL COVERAGE	DISPERSAL	WATER LAYER	
		(FT)	(SQ FT)	(GAL/SQ FT)	(IN/SQ FT)	(FT)	(SQ FT)	(GAL/SQ FT)	(IN/SQ FT)	
MPH	FPM									
U S	2	176	5535	459371	0.065	0.105	3511	263298	0.114	0.183
	5	440	13836	1148428	0.026	0.042	8777	658245	0.046	0.073
	10	880	27673	2296855		0.021	17553	1316489	0.023	0.037
	15	1320	41509	3445283	0.009	0.014	26330	1974734	0.015	0.024
M E T R I C	KPM	MPM	(METER)	(M SQ)	(L/M SQ)	(MM)	(METERS)	(M SQ)	(M/M SQ)	(MM)
	3	53	1667	41670	2.725	2.67	1057	24316	4.670	4.65
	8	134	4214	105354	1.078	1.07	2673	61479	1.847	1.84
	16	268	8428	210708	0.539	0.53	5346	122957	0.924	0.94
	24	402	12642	316062	0.359	0.35	8019	184436	0.616	0.61

HEAVY SPRAY (3/8" SLOT HEIGHT) & FULL FAN (113562 lit/30,000 gal TANK)

SPEED		2 SPRAY HEADS (FLOW 4705 lpm/1243 gpm)				4 SPRAY HEADS (FLOW 5950 lpm/1572 gpm)				
		SPRAY DISTANCE	TOTAL COVERAGE	DISPERSAL	WATER LAYER	MAX DISTANCE	TOTAL COVERAGE	DISPERSAL	WATER LAYER	
		(FT)	(SQ FT)	(GAL/SQ FT)	(IN/SQ FT)	(FT)	(SQ FT)	(GAL/SQ FT)	(IN/SQ FT)	
MPH	FPM									
U S	2	176	4248	331327	0.091	0.145	3359	218321	0.137	0.220
	5	440	10619	828319	0.036	0.058	8397	545802	0.055	0.088
	10	880	21239	1656637	0.018	0.029	16794	1091603	0.027	0.044
	15	1320	31858	2484956	0.012	0.019	25191	1637405	0.018	0.029
M E T R I C	KPM	MPM	(METER)	(M SQ)	(L/M SQ)	(MM)	(METERS)	(M SQ)	(M/M SQ)	(MM)
	3	53	1279	30702	3.699	3.68	1012	20231	5.613	5.59
	8	134	3234	77623	1.463	1.47	2558	51151	2.220	2.23
	16	268	6469	155246	0.731	0.74	5115	102301	1.110	1.11
	24	402	9703	232868	0.488	0.48	7673	153452	0.740	0.74

SECTION 5 Performance

FINE SPRAY (1/4" SLOT HEIGHT) & FULL FAN (132489 lit/35,000 gal TANK)

SPEED		2 SPRAY HEADS (FLOW 3611 lpm/954 gpm)				4 SPRAY HEADS (FLOW 5693 lpm/1504 gpm)				
		SPRAY DISTANCE	TOTAL COVERAGE	DISPERSAL	WATER LAYER	MAX DISTANCE	TOTAL COVERAGE	DISPERSAL	WATER LAYER	
		(FT)	(SQ FT)	(GAL/SQ FT)	(IN/SQ FT)	(FT)	(SQ FT)	(GAL/SQ FT)	(IN/SQ FT)	
MPH	FPM									
U S	2	176	6457	535933	0.065	0.105	4096	307181	0.114	0.183
	5	440	16143	1339832	0.026	0.042	10239	767952	0.046	0.073
	10	880	32285	2679665	0.013	0.021	20479	1535904	0.023	0.037
	15	1320	48428	4019497	0.009	0.014	30718	2303856	0.015	0.024
M E T R I C	KPM	MPM	(METER)	(M SQ)	(L/M SQ)	(MM)	(METERS)	(M SQ)	(M/M SQ)	(MM)
	3	53	1945	48615	2.725	2.67	1233	28369	4.670	4.65
	8	134	4917	122913	1.078	1.07	3118	71725	1.847	1.84
	16	268	9833	245826	0.539	0.53	6237	143450	0.924	0.94
	24	402	14750	368738	0.359	0.35	9355	215175	0.616	0.61

HEAVY SPRAY (3/8" SLOT HEIGHT) & FULL FAN (132489 lit/35,000 gal TANK)

SPEED		2 SPRAY HEADS (FLOW 4705 lpm/1243 gpm)				4 SPRAY HEADS (FLOW 5950 lpm/1572 gpm)				
		SPRAY DISTANCE	TOTAL COVERAGE	DISPERSAL	WATER LAYER	MAX DISTANCE	TOTAL COVERAGE	DISPERSAL	WATER LAYER	
		(FT)	(SQ FT)	(GAL/SQ FT)	(IN/SQ FT)	(FT)	(SQ FT)	(GAL/SQ FT)	(IN/SQ FT)	
MPH	FPM									
U S	2	176	4956	386549	0.091	0.145	3919	254707	0.137	0.220
	5	440	12389	966372	0.036	0.058	9796	636768	0.055	0.088
	10	880	24779	1932743	0.018	0.029	19593	1273537	0.027	0.044
	15	1320	37168	2899115	0.012	0.019	29389	1910305	0.018	0.029
M E T R I C	KPM	MPM	(METER)	(M SQ)	(L/M SQ)	(MM)	(METERS)	(M SQ)	(M/M SQ)	(MM)
	3	53	1492	35818	3.699	3.68	1180	23603	5.613	5.59
	8	134	3773	90560	1.463	1.47	2984	59676	2.220	2.23
	16	268	7547	181120	0.731	0.74	5968	119351	1.110	1.11
	24	402	11320	271680	0.488	0.48	8951	179027	0.740	0.74

SECTION 5 Performance

FINE SPRAY (1/4" SLOT HEIGHT) & FULL FAN (158,988 lit/42,000 gal TANK)

SPEED		2 SPRAY HEADS (FLOW 3611 lpm/954 gpm)				4 SPRAY HEADS (FLOW 5693 lpm/1504 gpm)				
		SPRAY DISTANCE	TOTAL COVERAGE	DISPERSAL	WATER LAYER	MAX DISTANCE	TOTAL COVERAGE	DISPERSAL	WATER LAYER	
		(FT)	(SQ FT)	(GAL/SQ FT)	(IN/SQ FT)	(FT)	(SQ FT)	(GAL/SQ FT)	(IN/SQ FT)	
MPH	FPM									
U S	2	176	7748	643119	0.065	0.105	4915	368617	0.114	0.183
	5	440	19371	1607799	0.026	0.042	12287	921543	0.046	0.073
	10	880	38742	3215597	0.013	0.021	24574	1843085	0.023	0.037
	15	1320	58113	4823396	0.009	0.014	36862	2764628	0.015	0.024
M E T R I C	KPM	MPM	(METER)	(M SQ)	(L/M SQ)	(MM)	(METERS)	(M SQ)	(M/M SQ)	(MM)
	3	53	2334	58338	2.725	2.67	1480	34043	4.670	4.65
	8	134	5900	147496	1.078	1.07	3742	86071	1.847	1.84
	16	268	11800	294993	0.539	0.53	7484	172142	0.924	0.94
	24	402	17700	442489	0.359	0.35	11227	258212	0.616	0.61

HEAVY SPRAY (3/8" SLOT HEIGHT) & FULL FAN (158,988 lit/42,000 gal TANK)

SPEED		2 SPRAY HEADS (FLOW 4705 lpm/1243 gpm)				4 SPRAY HEADS (FLOW 5950 lpm/1572 gpm)				
		SPRAY DISTANCE	TOTAL COVERAGE	DISPERSAL	WATER LAYER	MAX DISTANCE	TOTAL COVERAGE	DISPERSAL	WATER LAYER	
		(FT)	(SQ FT)	(GAL/SQ FT)	(IN/SQ FT)	(FT)	(SQ FT)	(GAL/SQ FT)	(IN/SQ FT)	
MPH	FPM									
U S	2	176	5947	463858	0.091	0.145	4702	305649	0.137	0.220
	5	440	14867	1159646	0.036	0.058	11756	764122	0.055	0.088
	10	880	29735	2319292	0.018	0.029	23511	1528244	0.027	0.044
	15	1320	44602	3478938	0.012	0.019	35267	2292366	0.018	0.029
M E T R I C	KPM	MPM	(METER)	(M SQ)	(L/M SQ)	(MM)	(METERS)	(M SQ)	(M/M SQ)	(MM)
	3	53	1791	42983	3.699	3.68	1416	28324	5.613	5.59
	8	134	4528	108673	1.463	1.47	3581	71611	2.220	2.23
	16	268	9056	217346	0.731	0.74	7161	143223	1.110	1.11
	24	402	13584	326018	0.488	0.48	10742	214834	0.740	0.74

SECTION 5 Performance

FINE SPRAY (1/4" SLOT HEIGHT) & FULL FAN (196,841 lit/52,000 gal TANK)

SPEED		2 SPRAY HEADS (FLOW 3611 lpm/954 gpm)				4 SPRAY HEADS (FLOW 5693 lpm/1504 gpm)				
		SPRAY DISTANCE	TOTAL COVERAGE	DISPERSAL	WATER LAYER	MAX DISTANCE	TOTAL COVERAGE	DISPERSAL	WATER LAYER	
		(FT)	(SQ FT)	(GAL/SQ FT)	(IN/SQ FT)	(FT)	(SQ FT)	(GAL/SQ FT)	(IN/SQ FT)	
MPH	FPM									
U S	2	176	9339	775118	0.067	0.108	8320	624000	0.083	0.134
	5	440	23347	1937796	0.027	0.043	20800	1560000	0.033	0.053
	10	880	46694	3875592	0.013	0.022	41600	3120000	0.017	0.027
	15	1320	70041	5813388	0.009	0.014	62400	4680000	0.011	0.018
M E T R I C	KPM	MPM	(METER)	(M SQ)	(L/M SQ)	(MM)	(METERS)	(M SQ)	(M/M SQ)	(MM)
	3	53	2755	68877	2.800	2.67	2455	56454	3.416	3.42
	8	134	6966	174143	1.107	1.07	6206	142734	1.351	1.35
	16	268	13931	348285	0.554	0.53	12412	285467	0.676	0.68
	24	402	20897	522428	0.369	0.35	18617	428201	0.450	0.45

HEAVY SPRAY (3/8" SLOT HEIGHT) & FULL FAN (196,841 lit/52,000 gal TANK)

SPEED		2 SPRAY HEADS (FLOW 4705 lpm/1243 gpm)				4 SPRAY HEADS (FLOW 5950 lpm/1572 gpm)				
		SPRAY DISTANCE	TOTAL COVERAGE	DISPERSAL	WATER LAYER	MAX DISTANCE	TOTAL COVERAGE	DISPERSAL	WATER LAYER	
		(FT)	(SQ FT)	(GAL/SQ FT)	(IN/SQ FT)	(FT)	(SQ FT)	(GAL/SQ FT)	(IN/SQ FT)	
MPH	FPM									
U S	2	176	7363	574301	0.091	0.145	5822	378422	0.137	0.220
	5	440	18407	1435752	0.036	0.058	14555	946056	0.055	0.088
	10	880	36814	2871504	0.018	0.029	29109	1892112	0.027	0.044
	15	1320	55221	4307257	0.012	0.019	43664	2838168	0.018	0.029
M E T R I C	KPM	MPM	(METER)	(M SQ)	(L/M SQ)	(MM)	(METERS)	(M SQ)	(M/M SQ)	(MM)
	3	53	2172	52135	3.699	3.68	1718	34355	5.613	5.61
	8	134	5492	131812	1.463	1.47	4343	86859	2.220	2.22
	16	268	10984	263625	0.731	0.74	8686	173719	1.110	1.11
	24	402	16477	395437	0.488	0.48	13029	260578	0.740	0.74

SECTION 5

Performance

FIRE SUPPRESSION SYSTEM

The table below shows consumption rates and duration of foam suppression concentrate and water based upon a standard flow rate 1893 lpm/500 gpm and 3% foam proportioning.

Foam Concentrate liters/gallons	Water liters/gallons	Duration
57/15	1893/500	1 minute
114/30	3786/1000	2 minutes
228/60	7571/2000	4 minutes
341/90	11,357/3000	6 minutes
455/120	15,142/4000	8 minutes

SECTION 6 Employment

Contents

Description	6-1	Distance Based Programming	6-7
Spray Heads	6-1	Tank Drain.....	6-8
Dust Suppression	6-4	Dump Bar.....	6-8
Intermittent Spray.....	6-5	Water Cannon	6-9
Troubleshooting	6-6	Fire Suppression System	6-9
Speed Based Programming (Discs®).....	6-6		

DESCRIPTION

This section provides descriptions, guidance, and techniques used when employing the MEGA spray system features. These best practices will provide operators with several choices that will result in maximum system performance in most applications.

SPRAY HEADS

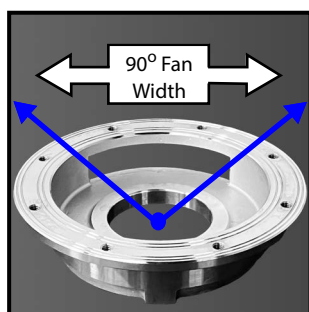

Spray head adjustment and fine tuning techniques are key factors in optimizing water distribution and preventing over-watering of roadways. The MEGA spray heads are mounted to base plate assemblies connected to the water discharge piping. MEGA spray heads can be rotated on the base plate to direct the discharge fan in the necessary directions for optimum spray pattern. The spray heads incorporate an adjustable ring to control the spray intensity and fan width. The opening in the base of the MEGA spray head will allow for approximately a 90° maximum fan width as illustrated above.

Fan Width And Spray Intensity Adjustment

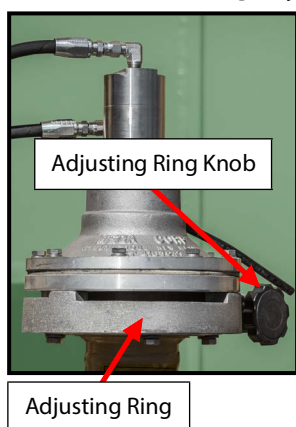

The spray head adjusting ring is used to control the fan width and spray intensity to match most applications. These settings can be changed by first loosening the adjusting ring knob and then rotating the adjusting ring to the desired position.

Fine Spray (1/4" Slot Height)

The following images are examples of the adjustment ring at the "fine spray" setting with varying fan widths. The "fine spray" setting is typically used for reduced water volumes and a larger pattern, and is best suited for lower vehicle speeds and low water pump rpm.

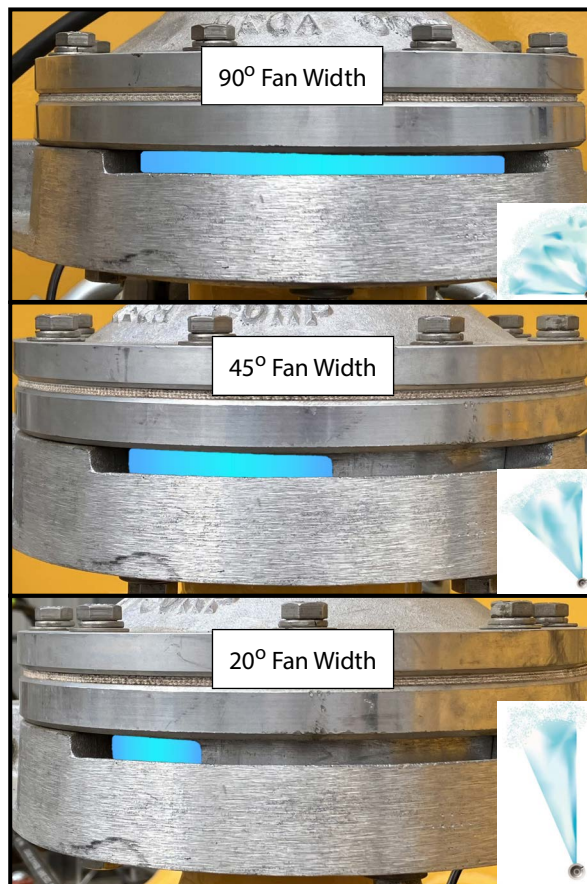

NOTE

- Adjusting the ring for narrower fan widths will increase the length of the spray pattern; this may also increase the closure delay of the spray head.
- The "fine spray" setting produces smaller water droplets ideal for low wind and high humidity conditions.

SECTION 6 Employment

Heavy Spray (3/8" Slot Height)

The following images are examples of the adjustment ring at the "heavy spray" setting with varying fan widths. The "heavy spray" setting is typically used for heavy watering and discharging large quantities of water a short distance from spray head, and is best suited for higher vehicle speeds and high engine rpm.

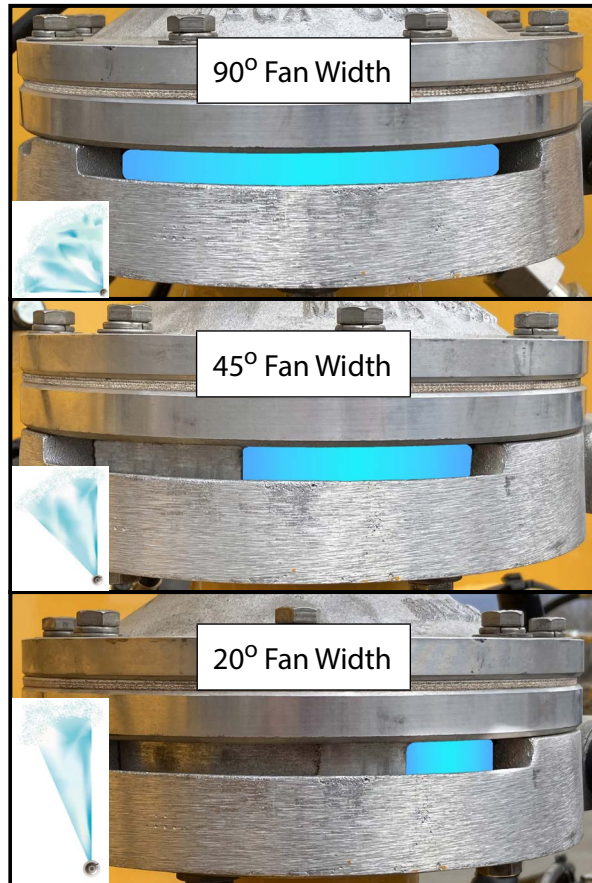

Spray Head Vertical Tilt Adjustment

Swivel joints are an optional feature for spray head mounting. The joint allows the spray head to be tilted up or down to suit a given application. In their default positions, the spray heads discharge water at an angle of 10° above level. This results in more uniform droplet formation and subsequent water coverage. However, in drier climates or high wind conditions where evaporation is a significant source of water loss, it may be desirable to adjust the tilt of the spray heads towards the ground, thus reducing the amount of water lost to the effects of wind and low humidity. To adjust the vertical tilt of spray heads, loosen the elbow couplings and adjust the swivel elbows (as shown below) down to the desired angle.

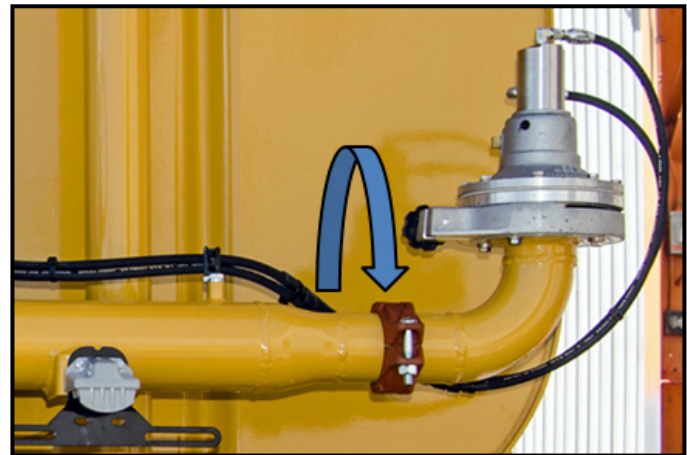

NOTE

Angling the spray heads down is typically used for high wind conditions and narrow watering strips.

NOTE

- When the spray head is set for "heavy spray", water pressure is decreased and the reach of the discharge is reduced.
- The heavy spray setting produces larger water droplets ideal for high wind and low humidity conditions.
- When more than 2 spray heads are operated at the same time, the performance of the spray system is reduced.

SECTION 6

Employment

Spray Head Fan Pattern

Proper employment of the spray system includes spray head adjustments to best suit the desired application. 'Best practices' are adjustments to the procedures that address the situation more accurately. Every application has specific conditions that must be addressed, such as safety, weather conditions, terrain, traffic, traction and proximity to sensitive equipment and personnel.

Steps for accurate spray system employment are as follows:

1. Select spray head fan height to meet road and watering pattern requirements.
 2. Set spray head adjusting ring to the maximum fan width.
 3. Evaluate road conditions for width, grade, vehicle traffic and optimum travel speed.
 4. Locate an isolated section of road to test spray pattern.
 5. Follow Operator's Manual steps for water pump activation and spray head operation.
 6. Operate water truck and turn all spray heads ON. Ensure uniform water distribution and coverage.
7. Apply a test pattern by operating 1 spray head at a time on road surface traveling at a safe and average speed until all spray heads have been cycled. Note engine rpm while discharging water.
 8. Observe applied watering pattern. Adjust spray head discharge angle, and fan opening height and width to suit 'best practices' for the haul road application.

NOTE

- Water discharge pressure and volume are dependent on engine rpm. The higher the engine rpm, the higher the water pressure. Adjustments to vehicle speed, engine rpm, and spray head angle may be required.
- Adjusting the vehicle gear shift selector may be required in order to obtain the engine rpm necessary for the desired water pump performance level.

NOTE

During initial spray pattern testing, observe spray head closure delay. Delayed spray head closure is caused by the mechanical limitations of the hydraulic spray system. These noted delays will be helpful in predicting the actual closure rate of the spray heads when adjusting the spray pattern for oncoming traffic, obstacles and setting up strip watering or checkerboard patterns either manually or if equipped with the intermittent spray timer.

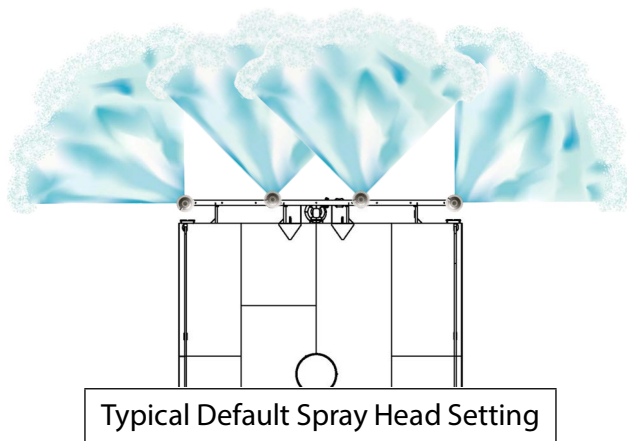

SECTION 6 Employment

Vertical Side Spray Heads

Vertical side spray heads are typically located on the front or rear of the top skin of the water tank. The discharge opening is vertical to the tank and sprays to the side. Vertical side spray heads can be employed for applying water to high walls, reaching over berms, or watering opposing traffic lanes. Vertical side spray heads **cannot** be controlled using the intermittent function.



⚠️ WARNING

Vertical side spray is not recommended for use when high winds are present. Due to the spray head locations on the top of the water tank, the wind will unevenly distribute the water and may carry the water where it obstructs the view from the operator's position, potentially impairing visibility and thereby creating dangerous operating conditions.



Front Bumper Spray Heads

Front bumper spray heads are used and adjusted like any other spray head for haul road and berm operations. Spray heads mounted to a swiveling coupling allow the fan pattern to be pointed down towards the road and perform as a street sweeper. This same configuration is very effective when water patterns are needed to penetrate the ground surface for compaction operations.

DUST SUPPRESSION

For dust suppression it is recommended that a light coating of water be applied to the road surface. This can be achieved by monitoring and adjusting the engine rpm and vehicle speed with properly adjusted spray heads that allow an even coating of water to fall onto the road surface. Typically 1 or 2 spray heads are employed for this application.

Examples for light water distribution:

Adjusting ring opening - FULL WIDTH, FINE SPRAY

Right rear spray head - ON

Right center spray head - OFF

Left center spray head - ON

Left rear spray head - OFF

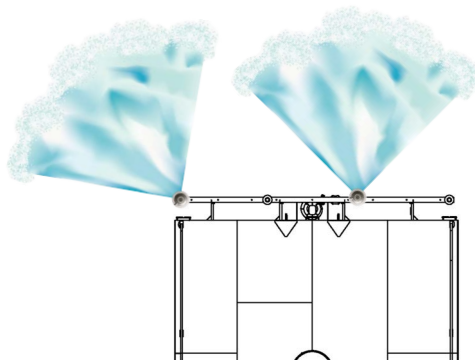

Typical Reduced Volume Spray Head Setting

Adjusting Ring Opening - FULL WIDTH, FINE SPRAY

Right rear spray head - OFF

Right center spray head - ON

Left center spray head - OFF

Left rear spray head - ON

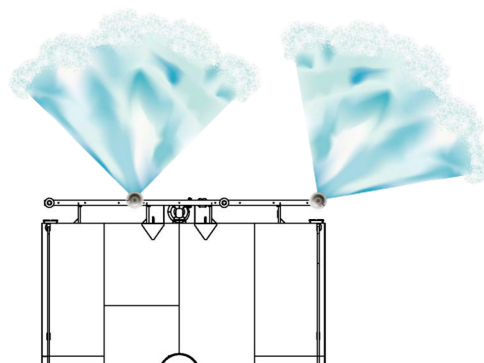

Typical Reduced Volume Spray Head Setting

SECTION 6

Employment

Adjusting ring opening - FULL WIDTH, FINE SPRAY
 Right rear spray head - ON
 Right center spray head - OFF
 Left center spray head - OFF
 Left rear spray head - ON

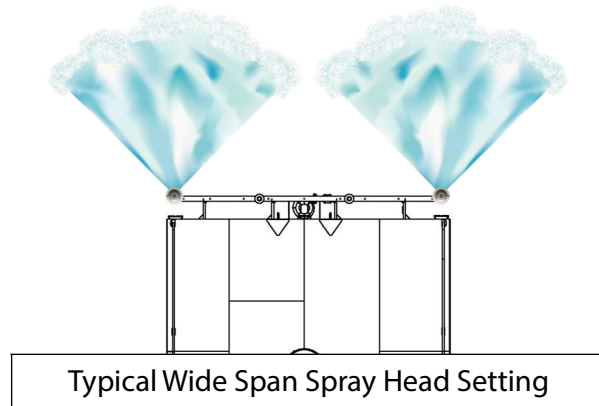

INTERMITTENT SPRAY

Intermittent spray is a time based function. Individual control knobs set the ON and OFF time of the spray heads based on the desired length of time needed to apply wet/dry strips on the road. The standard MEGA spray system with intermittent spray has a timer range of 5 to 100 seconds. The DiSCS® spray system intermittent spray has a timer range of 3 to 30 seconds.

Intermittent spray control is best suited for light watering and pit ramps, where it is desired to have definite wet and dry sections of road, and where additional driver attention to road conditions is required. This wet and dry strip watering provides for better traction, allowing haul trucks and other vehicles to drag water down the haul road while also increasing water truck duration between tank refills.

NOTE

Due to the mechanical limitations of the spray system, the timer control range refers to the requests to open and close the spray head; delays in closure may be experienced.

1. Ensure tank is full of water.
2. Adjust spray head openings to desired settings.
3. Turn system/power switch ON.

4. Turn intermittent (analog) or time based program (DiSCS®) switch ON.
5. Set intermittent timer knobs (analog) or wet/dry switches (DiSCS®) to desired time of spray pattern.
6. Turn pump switch ON.

CAUTION

Do not engage/disengage the water pump above LOW IDLE. Engaging/disengaging the water pump above low idle will result in water pump component damage and reduced service life.

7. Select spray heads required for desired road condition.
8. Operate water tanker on desired route and observe spray pattern.
9. Adjust timing as desired to create the necessary wet/dry strips.

While in intermittent mode, all discharge functions can be turned OFF by turning off the corresponding function switch. If the function is turned ON while the timer is in the OFF cycle, the function will stay OFF until the next ON cycle. The illustrations below are examples of strip watering:



SECTION 6

Employment

TROUBLESHOOTING

If the following conditions occur, adjust as follows and re-test spray patterns until the optimal pattern is achieved.

Discharge Spray Extends to and Beyond Berms or Into Oncoming Traffic.

1. Adjust spray head width toward center of truck by loosening the 4 retaining bolts on the bottom of the spray heads and rotating the spray head on the base plate to the desired position.
2. Re-tighten spray head retaining bolts. Pay attention to washer engagement.

Insufficient Water On Roadway

1. Increase engine rpm by shifting to a lower gear.
2. Increase the number of spray heads activated.
3. Reduce vehicle speed.
4. Increase the spray intensity by rotating the adjusting ring to the "heavy spray" setting (3/4" slot height).

Excess Water On Roadway

1. Decrease engine rpm by selecting a higher gear.
2. Increase vehicle travel speed.
3. Reduce the number of spray heads activated.
4. Reduce the spray intensity by rotating the adjusting ring to the "fine spray" setting (1/4" slot height).

SPEED BASED PROGRAMMING (DISCS®)

The resident software provides a consistent layer of water on haul roads regardless of ground speed. The software reduces water usage and prevents puddling at stops and haul ramps. Nominal settings produce about 3 liters per cubic meter regardless of ground speed. This maximizes water usage and extends the duration of a given load of water. Adjustments are provided to increase or decrease the layer of water dispersed, as well as setting maximum water flow at a desired ground speed. Below is an example of a system setup and what behaviors will be observed from the system:

Example 1 (Medium Speed & High Winds)

Setup:

1. COVERAGE - Set at midpoint (50%)
2. SPEED - 24 kph/15 mph)
3. SPEED BASED – ON
4. SPRAY HEADS - Select all rear spray heads

Observed Operation:

- Vehicle speed → 24 kph/15 mph and greater rear spray heads ON.
- Vehicle speed → 16 kph/10 mph – 2 inner spray heads turn OFF
- Vehicle speed → 13 kph/8 mph – 2 outer spray heads begin to pulse (10 second cycles) to maintain approximately 50% water coverage (50% spray head ON/50% spray head OFF during the cycle).
- Vehicle speed → 5 kph/3 mph or less – All spray heads turn OFF.

SECTION 6 Employment

DISTANCE BASED PROGRAMMING

Programming the software program provides a “checkerboard banding” pattern of set wet patch and dry bands as the program automatically alternates right and left spray heads. This pattern provides dry spots for traction, reduces water usage and increases tanker duration. Below are examples of the adjusted “checkerboard” pattern:

SETTINGS <i>0 Meters DRY</i>	
WET	DRY
DRY	WET
WET	DRY
DRY	WET
WET	DRY

SETTINGS <i>Short WET Long DRY</i>	
WET	DRY
DRY	
DRY	WET
DRY	
WET	DRY

SETTINGS <i>Equal WET/DRY</i>	
WET	DRY
DRY	
DRY	WET
DRY	
WET	DRY

SETTINGS <i>Long WET Short DRY</i>	
WET	DRY
DRY	
DRY	WET
DRY	
WET	DRY

SECTION 6 Employment



TANK DRAIN

Remote or manually operated drain valves are typically used to drain water from the tank after daily operations or when the water tank is prepared for maintenance. Gravity or pressure tank drains are also employed successfully in water haulage or supply operations. Pressurized drain systems work well

when performing bulk water haulage from a main supply site to remote fill sites or established holding ponds. This pressurized system is also effective in providing water for drilling and fire suppression operations.

DUMP BAR



The dump bar application is for laying a heavy defined pattern of water directly onto the roadway. This application can be used for increasing the moisture content of road beds for compaction, confined areas for which the use of the spray heads is not desired, narrow haul roads where discharge beyond the side of the tanker is not required, confined application in high wind conditions, and preparation of roadways for grader applications. The dump bar function is capable of being operated in the intermittent mode.

The pressure dump bar is designed to force water into the upper layer of the road. The pressure feature is also useful for high wind conditions at high ground speeds.

CAUTION

If the dump bar is activated (pressure or gravity) and the water tanker has stopped, damage to the road surface can occur. Ensure that the dump bar is **off** when coming to a stop to prevent road surface damage. Physical and mechanical delays will occur when turning the dump bar off.

NOTE

The gravity dump bar can also be used as a tank drain.

SECTION 6

Employment

WATER CANNON



The water cannon system is versatile for many different mining and construction applications. The straight bore nozzles work very well in producing a straight stream of water able to reach out at long distances. The water cannon will obtain maximum reach when the nozzle is at about 32 degrees of elevation with the chassis rpm at high idle. Reach can further be increased with the addition of in-line stream shaper when extreme reach is required for “high wall” or “stockpile” operations.

The water cannon system is also useful for “wash down” operations. The system is best suited for wash down when configured with a remote adjustable “stream to fan/fog” nozzle. The operator can adjust the fan or stream pattern as needed while directing the stream or fan towards the components for wash down. The operator may also control water flow and pressure by simply increasing or decreasing the chassis rpm to obtain desired water flow and pressure.

CAUTION

Do not point straight streams directly at cab windows, exhausts or sensitive components. Equipment damage can be caused when water cannon is flowing at maximum flow and pressure.

FIRE SUPPRESSION SYSTEM



The fire suppression operations are never typical and the environment is ever changing. Operators must always be aware of the type of fire they are suppressing, wind conditions, potential hazards surrounding the fire, potential heat generated by the fire and the duration of the fire suppression system. General guideline for fire suppression operations are:

1. Have a basic understanding of the different classes of fires (A, B, C, and D) and how to extinguish them.
2. Be familiar with site specific standard operating procedures for fire suppression.
3. Understand basic fire suppression techniques for applying foam blankets (rain-down, and bounce-up).
4. Ensure fire suppression holding tank is full, system components are serviceable and the entire system is operational before employing the system for an actual fire.
5. Obtain situational awareness of the site:
 - a. On scene commander and establish communication.
 - b. People and equipment involved in the fire.
 - c. Duration of the fire suppression system.
 - d. Wind direction at the site.
 - e. Hazards and restrictions at the site.
 - f. Emergency support people and equipment.
6. Head to the site and perform operational check of the fire suppression system.
7. Activate the water pump.

SECTION 6

Employment

8. Approach the site from a safe direction based on observed winds and known hazards.
9. Activate the fire suppression system as contained in Section 4 "Normal Operations".
10. Lay down an initial foam protective blanket as required.
11. Maintain a foam protective blanket as required or as duration allows.
12. Always be aware of hazards, wind conditions and remaining fire suppression duration.
13. Once fire suppression is completed, secure system as contained in Section 4 "Normal Operations".
14. Ensure water truck is completely washed down after fire suppression operations.

Appendix

MAC/MTT Operator's Checklist

Place a copy of this Operator's Checklist in the cab.

MAC/MTT-OPS(CL)-1

17 May 2024



MAC/MTT OPERATOR'S CHECKLIST

APPENDIX

MAC/MTT Operator's Checklist

MAC/MTT-OPS(CL)-1.

17 May 2024

TABLE OF CONTENTS

Title	Page
1. BEFORE OPERATIONS	N-2
2. OPERATIONS	
A. Spray Head System.....	N-4
B. Time Based Mode (Banding).....	N-5
C. Distance Based Mode	N-7
D. Speed Based Mode.....	N-8
E. Dump Bar.....	N-9
F. Water Cannon.....	N-11
G. Fire Suppression System.....	N-13
H. Tank Drain	N-16
I. Hose Reel.....	N-17
J. Water Circulation System.....	N-19
K. Suction Load Station	N-20
3. AFTER OPERATIONS.....	N-23
4. COLD WEATHER OPERATION	N-24
(AND STORAGE)	
5. UNIT REACTIVATION	N-26

N-1

APPENDIX

MAC/MTT Operator's Checklist

MAC/MTT-OPS(CL)-1.

17 May 2024

BEFORE OPERATIONS

These procedures are used to perform a walk-around inspection of the MEGA water tanker system before use or the beginning of a shift. This inspection is in addition to and does not replace the vehicle manufacturer's inspection requirements.

1. Chocks – AS REQUIRED
2. Vehicle parking brake – ON
3. Cab control switches – OFF
4. Foam concentrate level – CHECKED
 - a. Level should be at least 1" from the top of the foam tank.

WARNING

Ensure PPE fall arrest harness is worn, adjusted properly and attached to an anchor point. Failure to use PPE properly may result in personnel injury or death.

5. Water cannon – INSPECT FOR SECURITY, DAMAGE & LEAKS
 - a. Nozzle – Check for security and kinking of foam concentrate supply line.

N-2

APPENDIX

MAC/MTT Operator's Checklist

MAC/MTT-OPS(CL)-1.

17 May 2024

6. Solenoid control box – INSPECT FOR SECURITY, DAMAGE & LEAKS
7. Tanker front mounts – INSPECT FOR SECURITY & DAMAGE
8. Vehicle hydraulic tank – SERVICED
9. Tanker LH hydraulic hoses and cabling – INSPECT FOR SECURITY, DAMAGE & LEAKS
10. Chassis pivot bore pins – INSTALLED AND SECURED
11. Tank drain petcocks – CLOSED
12. Spray heads – SECURED & ADJUSTED FOR APPLICATION
13. Water pump assembly – INSPECT
 - a. Water pump – Check to ensure volute case drain valve is closed.
 - b. Water pump and drive motor for evidence of overheating.
14. Hose reel – INSPECT FOR SECURITY, DAMAGE & LEAKS

N-3

APPENDIX

MAC/MTT Operator's Checklist

MAC/MTT-OPS(CL)-1.

17 May 2024

15. Tanker RH hydraulic hosing & cabling – INSPECT FOR SECURITY, DAMAGE AND LEAKS

16. Front bumper spray heads & plumbing – SECURED AND SET

OPERATIONS

Use these procedures to safely operate the standard and optional systems installed on the MEGA water tanker. Note that some operations are applicable to DiSCS® only.

CAUTION

Limit water pump operation to 2.5 minutes when in a no-flow condition (not flowing water through spray heads, dump bar, monitor, drain valve or hose reel). Water pump operation in a no flow condition will cause overheating of the water pump and damage to the shaft bearings and seals.

Spray Head System

NOTE

Operating more than 4 spray heads simultaneously will greatly reduce the width and flow of active spray heads.

1. Cab control system/power switch – ON

N-4

APPENDIX

MAC/MTT Operator's Checklist

MAC/MTT-OPS(CL)-1.

17 May 2024

2. Pump switch – ON

CAUTION

Do not engage/disengage the water pump above LOW IDLE. Engaging/disengaging the water pump above low idle will result in water pump component damage and reduced service life.

3. Individual spray heads – SELECTED AS REQUIRED

Once operations are complete:

4. Pump switch – OFF

CAUTION

Do not engage/disengage the water pump above LOW IDLE. Engaging/disengaging the water pump above low idle will result in water pump component damage and reduced service life.

5. Cab control system/power switch – OFF

Time Based Mode (Banding)

Operator can cycle on/off periods of spray using selected time intervals. *Refer to Section 2 - DiSCS® "Time Based Program Mode" for complete operation details.*

N-5

APPENDIX

MAC/MTT Operator's Checklist

MAC/MTT-OPS(CL)-1.

17 May 2024

1. Cab control power switch – ON
2. Intermittent – SET AS REQUIRED
 - a. Timer on/off (wet/dry) – SET AS REQUIRED
3. Pump switch – ON

CAUTION

Do not engage/disengage the water pump above LOW IDLE. Engaging/disengaging the water pump above low idle will result in water pump component damage and reduced service life.

4. Individual spray heads or dump bar– SELECTED AS REQUIRED

Once operations are complete:

5. Pump switch – OFF

CAUTION

Do not engage/disengage the water pump above LOW IDLE. Engaging/disengaging the water pump above low idle will result in water pump component damage and reduced service life.

N-6

APPENDIX

MAC/MTT Operator's Checklist

MAC/MTT-OPS(CL)-1.

17 May 2024

6. Spray head/dump bar - OFF
7. Cab control system/power switch – OFF

Distance Based Mode (Checkerboard) (DiSCS®)

Operator can select alternating intermittent watering pattern that is dependent on distance traveled. Requires functioning GPS. *Refer to Section 2 - DiSCS® "Distance Based Program Mode"* for complete operation details.

1. Cab control power switch – ON
2. Distance based program mode – SELECTED
 - a. Wait for GPS lock - SWITCH LED GREEN
 - b. Wet/Dry intervals – SELECTED AS REQUIRED
3. Pump switch – ON

CAUTION

Do not engage/disengage the water pump above LOW IDLE. Engaging/disengaging the water pump above low idle will result in water pump component damage and reduced service life.

4. Individual spray heads – SELECTED AS REQUIRED

N-7

APPENDIX

MAC/MTT Operator's Checklist

MAC/MTT-OPS(CL)-1.

17 May 2024

Once operations are complete:

5. Spray heads - OFF
6. Pump switch – OFF

CAUTION

Do not engage/disengage the water pump above LOW IDLE. Engaging/disengaging the water pump above low idle will result in water pump component damage and reduced service life.

7. Cab control system/power switch – OFF

Speed Based Mode (Continuous Rate) (DiSCS®)

Operator can select an intermittent spray operation which provides a continuous rate of water application based on the speed traveled. Refer to *Section 2 - DiSCS® "Speed Based Program Mode"* for complete operation details.

1. Cab control power switch – ON
2. Speed based program mode – SELECTED
 - a. Wait for GPS lock
 - b. Wet (coverage percentage)/Dry (maximum speed) intervals – SELECTED AS REQUIRED

N-8

APPENDIX

MAC/MTT Operator's Checklist

MAC/MTT-OPS(CL)-1.

17 May 2024

3. Pump switch – ON

CAUTION

Do not engage/disengage the water pump above LOW IDLE. Engaging/disengaging the water pump above low idle will result in water pump component damage and reduced service life.

4. Individual spray heads – SELECTED AS REQUIRED

Once operations are complete:

5. Spray heads - OFF

6. Pump switch – OFF

CAUTION

Do not engage/disengage the water pump above LOW IDLE. Engaging/disengaging the water pump above low idle will result in water pump component damage and reduced service life.

7. Cab control system/power switch - OFF

Dump Bar

1. Cab control system/power switch – ON

N-9

APPENDIX

MAC/MTT Operator's Checklist

MAC/MTT-OPS(CL)-1.

17 May 2024

2. Intermittent – SET AS REQUIRED
 - a. Timer on/off (wet/dry) – SET AS REQUIRED
3. Pump switch (pressure bar only)– ON

CAUTION

Do not engage/disengage the water pump above LOW IDLE. Engaging/disengaging the water pump above low idle will result in water pump component damage and reduced service life.

4. Dump bar switch – ON

Once operations are complete:

5. Dump Bar - OFF
6. Pump switch – OFF

CAUTION

Do not engage/disengage the water pump above LOW IDLE. Engaging/disengaging the water pump above low idle will result in water pump component damage and reduced service life.

7. Cab control system/power switch – OFF

N-10

APPENDIX

MAC/MTT Operator's Checklist

MAC/MTT-OPS(CL)-1.

17 May 2024

Water Cannon

1. Cab control system/power switch – ON
2. Pump switch – ON

CAUTION

Do not engage/disengage the water pump above LOW IDLE. Engaging/disengaging the water pump above low idle will result in water pump component damage and reduced service life.

3. **(Multi water cannon)** Select desired water cannon to control. Only one water cannon can be controlled at any given time.

NOTE

- After initial start-up, desired canon (1, 2, or 3) must be selected.
- The joystick controls will be inactive for 4 seconds while switching between controlling different water cannons.
- Some units are equipped with two or three water cannons. Auxiliary water cannons can be mounted to VSS pipping or vehicle front bumper. Additional switches are provided to select between the primary and auxiliary water cannons. The joystick box will operate the selected water cannon.

N-11

APPENDIX

MAC/MTT Operator's Checklist

MAC/MTT-OPS(CL)-1.

17 May 2024

4. Water cannon – POINTED IN A SAFE DIRECTION
5. Monitor/BFV switch – ON
6. Water cannon joystick – AS REQUIRED
7. Monitor/BFV switch – OFF

Once operations are complete:

8. Water cannon nozzle - STOW

CAUTION

Manual and remote adjustable nozzles must be stowed pointing vertically to reduce wear on water cannon joints. Leaving the nozzle in any other position will cause increased wear on water cannon joints and result in premature joint failure.

NOTE

If equipped with **multi water cannons**, STOW each nozzle.

N-12

APPENDIX

MAC/MTT Operator's Checklist

MAC/MTT-OPS(CL)-1.

17 May 2024

9. Pump switch – OFF

CAUTION

Do not engage/disengage the water pump above LOW IDLE. Engaging/disengaging the water pump above low idle will result in water pump component damage and reduced service life.

10. Cab control system/power switch – OFF

Fire Suppression System

1. Cab control system/power switch – ON
2. Pump switch – ON

CAUTION

Do not engage/disengage the water pump above LOW IDLE. Engaging/disengaging the water pump above low idle will result in water pump component damage and reduced service life.

3. Water Cannon – POINTED IN A SAFE DIRECTION

N-13

APPENDIX

MAC/MTT Operator's Checklist

MAC/MTT-OPS(CL)-1.

17 May 2024

4. Foam switch – ON

CAUTION

(If equipped with multi water cannons) Ensure that the foam switch is OFF before operating a different water cannon. Operating a water cannon with the foam switch on will cause damage to the water cannon and hydraulics.

5. Monitor/BFV switch – ON
6. Water cannon joystick – AS REQUIRED

Once operations are complete:

7. Foam switch – OFF
8. Water cannon – PURGED OF FOAM
 - a. Flow water through the monitor nozzle with the **foam switch off** to flush foam from the nozzle.
9. Monitor/BFV switch – OFF

N-14

APPENDIX

MAC/MTT Operator's Checklist

MAC/MTT-OPS(CL)-1.

17 May 2024

10. Water cannon nozzle – STOW

CAUTION

Manual and remote adjustable nozzles must be stowed pointing vertically to reduce wear on water cannon joints. Leaving the nozzle in any other position will cause increased wear on water cannon joints and result in premature joint failure.

NOTE

If equipped with **multi water cannons**, STOW each nozzle.

11. Pump switch – OFF

CAUTION

Do not engage/disengage the water pump above LOW IDLE. Engaging/disengaging the water pump above low idle will result in water pump component damage and reduced service life.

12. Cab control system/power switch – OFF

13. Vehicle – WASH OR FRESH WATER RINSE

- a. Ensure areas exposed to foam spray are clean.

N-15

APPENDIX

MAC/MTT Operator's Checklist

MAC/MTT-OPS(CL)-1.

17 May 2024

Tank Drain

NOTE

Pump switch ON is only required for pressurized tank drain option.

1. Cab control system/power switch – ON
2. Pump switch (pressure drain only)– ON

CAUTION

Do not engage/disengage the water pump above LOW IDLE. Engaging/disengaging the water pump above low idle will result in water pump component damage and reduced service life.

3. Drain switch – ON
4. Water level – AS REQUIRED

CAUTION

Do not operate the water pump in a dry sump. Dry operation will result in shaft seal damage.

Once operations are complete:

5. Drain switch – OFF

N-16

APPENDIX

MAC/MTT Operator's Checklist

MAC/MTT-OPS(CL)-1.

17 May 2024

6. Pump switch – OFF

CAUTION

Do not engage/disengage the water pump above LOW IDLE. Engaging/disengaging the water pump above low idle will result in water pump component damage and reduced service life.

7. Cab control system/power switch – OFF

Hose Reel

1. Hose nozzle – CLOSED
2. Hose – DEPLOY DESIRED LENGTH
3. Gate valve – OPEN
4. Cab control system/power switch – ON
5. Pump switch – ON
6. Hose reel switch (DiSCS®)– ON

CAUTION

Do not engage/disengage the water pump above LOW IDLE. Engaging/disengaging the water pump above low idle will result in water pump component damage and reduced service life.

N-17

APPENDIX

MAC/MTT Operator's Checklist

MAC/MTT-OPS(CL)-1.

17 May 2024

7. Vehicle rpm – SET
8. Hose nozzle – OPEN AS REQUIRED

Once operations are complete:

9. Hose nozzle – CLOSED
10. Vehicle rpm – LOW IDLE
11. Hose reel switch (DiSCS®)– OFF
12. Pump switch – OFF

CAUTION

Do not engage/disengage the water pump above LOW IDLE. Engaging/disengaging the water pump above low idle will result in water pump component damage and reduced service life.

13. Cab control system/power switch- OFF
14. Gate valve – CLOSED
15. Hose – DRAINED AND STOWED

N-18

APPENDIX

MAC/MTT Operator's Checklist

MAC/MTT-OPS(CL)-1.

17 May 2024

Water Circulation System

1. Tanker – FULL
2. Chassis – LOW IDLE
3. Cab control system/power switch – ON.
4. Pump switch – ON

CAUTION

Do not engage/disengage the water pump above LOW IDLE. Engaging/disengaging the water pump above low idle will result in water pump component damage and reduced service life.

5. Circulation valve – OPEN
 - a. Opens BFV that allows water pressure to mix water tank contents

NOTE

Keep the switch ON until water cannon or spray system is used to flow the water mixture. If switch is left ON, circulation system will significantly reduce water cannon reach.

N-19

APPENDIX

MAC/MTT Operator's Checklist

MAC/MTT-OPS(CL)-1.

17 May 2024

Once operations are complete:

6. Circulation valve – CLOSED
7. Pump switch – OFF
8. Cab control system/power switch – OFF

Suction Load Station

1. Water supply – ACCESSIBLE
2. Chassis – SECURED AND SAFE FOR EXITING
3. Foot valve – INSPECT FOR SECURITY & DAMAGE
4. Suction hoses – INSPECT FOR DAMAGE
 - a. Ensure suction hoses are connected properly to each other and the suction load inlet to prevent air leaks while in use.
5. Suction hoses – IMMERSED IN WATER SUPPLY

N-20

APPENDIX

MAC/MTT Operator's Checklist

MAC/MTT-OPS(CL)-1.

17 May 2024

6. **(M3 configured tankers)** Position all butterfly valves as indicated in the order as follows:
 - a. Sump valve - **CLOSE**
 - b. Suction valve - **OPEN**
 - c. Spray bar valve - **CLOSE**
 - d. Tank fill valve - **OPEN**

NOTE

Opening and closing valves in this sequence allows the water in the suction loading sump built inside of the tank to flood the water pump and suction hose. This will allow water pump to lift water from water source.

7. Water pump and suction hoses – PRIMED

CAUTION

Do not operate the water pump in a dry sump. Dry operation will result in shaft seal damage.

8. Foot valve – SUBMERGED
9. **(M4 configured tankers)** Diversion valve handle – SUCTION LOAD POSITION
10. Chassis – LOW IDLE

N-21

APPENDIX

MAC/MTT Operator's Checklist

MAC/MTT-OPS(CL)-1.

17 May 2024

11. Cab control system/power switch – ON.
12. **(DiSCS®)** Suction load switch – ON
13. Pump switch – ON

CAUTION

Do not engage/disengage the water pump above LOW IDLE. Engaging/disengaging the water pump above low idle will result in water pump component damage and reduced service life.

14. Chassis – HIGH IDLE

Once operations are complete:

15. Chassis – LOW IDLE
16. **(DiSCS®)** Suction load switch – OFF
17. Pump switch – OFF

CAUTION

Do not engage/disengage the water pump above LOW IDLE. Engaging/disengaging the water pump above low idle will result in water pump component damage and reduced service life.

N-22

APPENDIX

MAC/MTT Operator's Checklist

MAC/MTT-OPS(CL)-1.

17 May 2024

18. Cab control system/power switch – OFF
19. Chassis – OFF
20. **(M3 configured tankers)** Reposition all valves for spraying water as follows:
 - a. Suction valve - **CLOSE**
 - b. Sump valve - **OPEN**
 - c. Tank fill valve - **CLOSE**
 - d. Spray bar valve - **OPEN**
21. Suction hoses – DRAINED AND STOWED
22. **(M4 configured tankers)** Diversion valve handle – WATER PUMP POSITION

AFTER OPERATIONS

These procedures are used to perform a walk-around inspection after using the MEGA water tanker systems. This inspection is in addition to and does not replace the vehicle manufacturer's inspection requirements.

1. Vehicle park brake – ON
2. Cab control switches – OFF
3. Chocks – AS REQUIRED

N-23

APPENDIX

MAC/MTT Operator's Checklist

MAC/MTT-OPS(CL)-1.

17 May 2024

4. Water cannon – INSPECT FOR SECURITY & DAMAGE
5. Vehicle hydraulic tank - SERVICE AS REQUIRED
6. Tank lines and hoses – INSPECT FOR SECURITY, DAMAGE & LEAKS
7. Tank drains – AS REQUIRED
8. Spray heads – SECURED & SET
9. Water pump – INSPECT FOR SECURITY, DAMAGE & LEAKS
10. Hose reel – INSPECT FOR SECURITY, DAMAGE & LEAKS
11. Solenoid control box – INSPECT FOR SECURITY, DAMAGE & LEAKS

N-24

APPENDIX

MAC/MTT Operator's Checklist

MAC/MTT-OPS(CL)-1.

17 May 2024

COLD WEATHER OPERATIONS AND STORAGE

CAUTION

Ensure all water is drained from system when the temperatures are expected to fall below 4.4°C (40°F) for any period of time. Failure to ensure all systems are drained and free from standing water will result in ice formation, which will cause serious damage to shaft, operator, diaphragm, drive motor, water pump, or butterfly valve.

To ensure all water is drained from tank, complete the following:

1. Drain the tank using an appropriate method until the water level gauge reads **empty**.
2. Tanker – PARKED
 - a. Slight nose up angle to allow water to flow to the rear of the tank.
3. All drains (water pump, suction load pump, rear spray bar, front spray bar, etc.) – OPEN
4. Water pump sump cover – REMOVED
5. Chassis – LOW IDLE
6. Cab control system/power switch – ON

N-25

APPENDIX

MAC/MTT Operator's Checklist

MAC/MTT-OPS(CL)-1.

17 May 2024

7. Monitor/BFV switch – ON
8. Water Cannon Nozzle – FULLY DOWN

CAUTION

If equipped with **multi water cannons**, point each nozzle fully DOWN and OPEN each BFV to drain water from system or damage may occur to components.

9. Dump bar switch – ON
10. Drain switch – ON
11. Cab control system/power switch – OFF
12. Chassis – OFF
13. Hose reel – DRAIN
 - a. Hose – UNWIND
 - b. Nozzle – FULLY OPEN
 - c. Gate valve – OPEN
 - d. Allow water to drain.
 - e. Hose – REWIND
 - f. Gate valve – CLOSED
 - g. Nozzle – CLOSED
14. Verify **all** water is drained.

N-26

APPENDIX

MAC/MTT Operator's Checklist

MAC/MTT-OPS(CL)-1.

17 May 2024

UNIT REACTIVATION

1. Water pump bearings – LUBRICATE
 - a. See MX-2 maintenance manual for instructions.
2. Tank interior/coating – INSPECT
 - a. Free of damage and debris.
 - b. Interior coating (if applicable) for damage.
 - c. Clean or repair as required.
3. Sump cover(s) – INSTALL
 - a. Install **new** gasket(s).
4. Tank drains and petcocks – CLOSED
5. Chassis - LOW IDLE
6. Control system/power switch – ON
7. Individual spray head switches – OFF
8. Dump bar switch – OFF
9. Drain switch – OFF
10. Monitor/BFV switch – OFF
11. Cab control system/power switch – OFF
12. Chassis – OFF

N-27